



AEQ FORUM LITE

**ULTRA-COMPACT DIGITAL AUDIO MIXER
FOR BROADCAST APPLICATIONS**

USER'S MANUAL

ED. 06/21

V. 1.8 - 18/04/2023

Software version 4.38, March 2023

CONTENTS

1. INTRODUCTION.....	5
1.1. General description.....	5
1.2. Specifications.....	7
1.2.1. General morphology.....	7
1.2.2. Functionality.....	7
1.2.3. General features.....	7
1.2.4. Standard Inputs and Outputs.....	7
1.2.5. Optional Inputs and Outputs.....	8
1.2.6. System processing capacity.....	8
2. PHYSICAL DESCRIPTION OF THE UNIT.....	9
2.1. Description of the control surface.....	9
2.1.1. Channels.....	9
2.1.1.1. Routing keys.....	11
2.1.1.2. SELECT.....	11
2.1.1.3. Channel display.....	11
2.1.1.4. CUE.....	12
2.1.1.5. Active processes indicator.....	12
2.1.1.6. ON AIR LED.....	13
2.1.1.7. Fader.....	13
2.1.1.8. Channel activation keys.....	14
2.1.2. Control and monitoring section.....	15
2.1.2.1. Control VU meters.....	15
2.1.2.2. Programmable keys.....	16
2.1.2.3. Main display.....	17
2.1.2.4. Control room monitoring section.....	17
2.1.2.5. Studio room monitoring and Talkback sections.....	19
2.2. Audio engine description.....	21
2.2.1. Power supply.....	22
2.2.2. Auxiliary connections.....	23
2.2.2.1. GPIO.....	23
2.2.2.1.1. Opto-coupled GPI.....	23
2.2.2.1.2. Opto-coupled GPO.....	24
2.2.2.1.3. Physical contact GPO.....	25
2.2.2.2. Ethernet Port.....	26
2.2.2.3. Control and studio monitors.....	26
2.2.2.4. CUE.....	27
2.2.2.5. Control headphones.....	27
2.2.2.6. Studio headphones.....	27
2.2.3. Generic audio inputs and outputs.....	28
2.2.3.1. Accessing the programming jumpers.....	28
2.2.3.2. Digital inputs.....	30
2.2.3.3. Digital outputs.....	31
2.2.3.4. Analog inputs.....	33
2.2.3.5. Analog outputs.....	33
2.2.3.6. MIC/LINE inputs.....	34
2.2.3.7. USB inputs and outputs.....	36
2.2.3.8. AoIP inputs and outputs.....	37
2.2.4. Optional inputs/outputs modules.....	37
2.2.4.1. MAD1 multichannel optional module.....	37
2.2.4.2. Telephone hybrid optional module.....	38
2.2.5. Wiring.....	38
3. DESCRIPTION OF THE INTERNAL MENU.....	40
3.1. "CLOCK" menu.....	40
3.2. "LOGIN/LOGOUT" menu.....	42
3.3. "MEMORY" menu.....	43

3.4. "MAIN MENU".....	44
3.4.1. "INFO" menu.....	45
3.4.2. "SETUP" menu.....	46
3.4.3. "SELECT" menu.....	46
3.4.3.1. "INPUT" menu.....	47
3.4.3.1.1. Dynamics menu: Compressor/Limiter and Noise Gate.	48
3.4.3.1.2. Equalizer and filter menu.	51
3.4.3.1.3. Expanded information menu.	52
3.4.3.1.3.1. "CFG" menu.	53
3.4.3.1.3.2. "FADER" menu.	53
3.4.3.1.3.3. "ROUTE" menu.	54
3.4.3.2. "OUTPUT" menu.....	55
4. CONFIGURATION SOFTWARE.	57
4.1. "Administration" menu.....	60
4.1.1. "Configurations" submenu.	60
4.1.2. "User Levels" submenu.....	64
4.1.3. "User Configuration" submenu.....	68
4.1.4. "About Forum Lite Setup" submenu.....	70
4.2. "Hardware Configuration" menu.	70
4.2.1. "Board Configuration" submenu.....	71
4.2.1.1. "Internal Module/Virtual - Configuration" section.	72
4.2.2. "Mixer Bus Configuration" submenu.	77
4.2.2.1. Configuration of MPX buses menu. "Clean Feed" mode.	79
4.2.3. "I/O Configuration" submenu.	84
4.2.3.1. Advanced configuration of input channels menu.	85
4.2.3.2. Advanced configuration of output channels menu.....	89
4.2.4. "Monitoring Configuration" submenu.	90
4.2.4.1. "Studio Room Section".....	91
4.2.4.2. "Control Room Section".	91
4.2.5. "Visual Radio" submenu.	92
4.2.6. "NTP Client Configuration" submenu.....	94
4.2.7. "Vumeters" submenu.	95
4.2.8. "Options" submenu.	96
4.3. "Programmable Configuration" menu.	97
4.3.1. "Routing Configuration" submenu.....	97
4.3.2. "Programmable Keys" submenu.	99
4.3.2.1. Basic configuration of programmable keys.....	99
4.3.2.2. Configuration of "General" programmable keys.....	101
4.3.2.3. Configuration of "Salvo" programmable keys.	103
4.3.2.4. Configuration of "Codec" programmable keys.....	104
4.3.2.5. Configuration of "Multiplex" programmable keys.	108
4.3.2.6. Configuration of "Cue Reset" programmable key.	109
4.3.2.7. Configuration of "Orders" programmable keys.	109
4.3.2.8. Configuration of "Memory" programmable keys.	110
4.3.2.9. Configuration of "Studio Monitor Attenuation" programmable keys.....	110
4.3.2.10. Configuration of "Auto Cue" programmable key.	111
4.3.2.11. Configuration of "A/B Mode" programmable key.	111
4.3.2.12. Configuration of "To Mixer Bus" programmable keys.	112
4.3.3. "Mic Group Configuration" submenu.....	113
4.3.4. "Preset Configuration" submenu.....	115
4.3.4.1. Advanced configuration of Compressor/Limiter.....	117
4.3.4.2. Advanced configuration of Noise Gate.	118
4.3.4.3. Advanced configuration of Equalizer.	119
4.3.4.4. Advanced configuration of Low Pass Filter.....	120
4.3.4.5. Advanced configuration of High Pass Filter.	120
4.3.5. "SnapShot Configuration" submenu.	121
4.3.5.1. Advanced configuration of inputs.....	126
4.3.5.2. Advanced configuration of outputs.....	128
4.4. "Firmware Upgrade" menu.....	129

4.4.1. "Tree View" submenu.	129
4.4.2. "Upgrade View" submenu.	132
4.4.3. "Log View" submenu.	133
5. A.E.Q. GUARANTEE.	134
APPENDIX A. SIGNALLING CONNECTION.	135
APPENDIX B. ADDITIONAL INFORMATION.	140

1. INTRODUCTION.

1.1. General description.

AEQ FORUM LITE is an ultra-compact digital audio mixer for Radio and Television consisting in a control surface and audio engine, specially designed for ON AIR broadcast control, and very adaptable to different work situations. It comprises all the basic necessary functions for this kind of environments: automatic monitor cut, cough cut, fader start, signaling control, signals for external equipment automation, external communications management, intercom, etc.

Its reduced size makes this mixer perfectly adaptable to many different scenarios: self-control, control-studio, audio control in television, sound production, mixed configurations, integration in large systems, etc.

One of the main qualities of **AEQ FORUM LITE** is the extensive internal routing capacity which provides: 28 inputs and 30 outputs for analogue, digital or microphone audio signals, 16 or 32 inputs/outputs multichannel audio over an AoIP (audio over IP) link, 2 optional inputs/outputs for telephone hybrid and another 64 optional inputs/outputs multichannel audio over a MADI link (and exclusive regarding AoIP functionality: both options can't be active at the same time).



NOTE: The exterior of equipment and some screens may vary depending on version.

Control power and simplicity of use has been combined into **AEQ FORUM LITE** to meet from the most basic to advanced operation needs, from an 8 faders control surface.



WARNING

The cable that connects control and monitoring module and audio engine carries **power supply**. The same happens with the cable that connects control and monitoring module to the first 4 faders module and with the cables that connect the following 4 faders modules. In order to avoid any damage to the unit is **VERY IMPORTANT** to turn off the unit before connecting or disconnecting these cables.

All basic functions of activation, level adjustment and routing have their specific controls on each channel of the FORUM LITE surface, while less common adjustments are included in a set of contextual controls common to all channels and accessible with just one or two keystrokes: simplicity and clarity of use for dynamic control without handling error.

The flexibility offered through the configuration of AEQ FORUM LITE enables the free assignment of any audio input of the system to any control channel, and changing the distribution of signals from the surface itself or the associated configuration software.

The FORUM LITE digital mixer includes memory banks that store the settings for each signal: control surface signal distribution, routing to the output buses, management of parameters and activation of the different available audio processes. This allows the console to adapt easily to different programs with different technical requirements.

Its Ethernet port enables the local or remote interconnectivity, facilitating set-up and maintenance, monitoring and control.

FORUM LITE has also been designed to ensure interoperability with communications equipment and future developments by AEQ or other manufacturers.

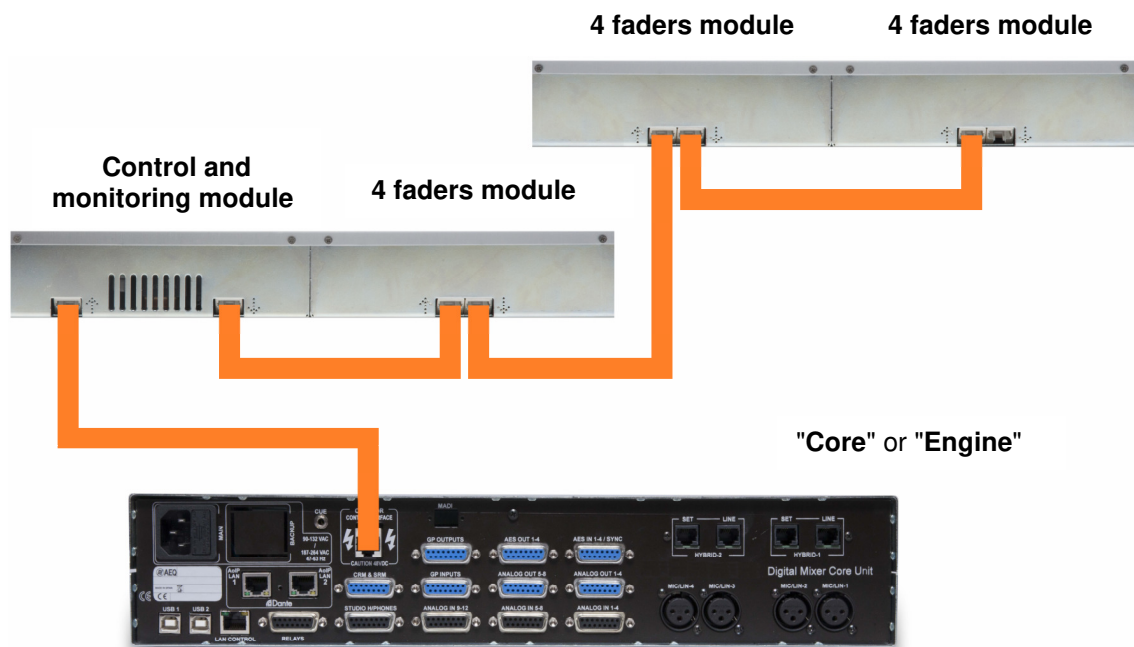

The data and power supply output from console to control surface is located at the right of the power supply input of the "core". It is designed for use with straight Ethernet cabling, but also carries proprietary **power supply lines**. Please use the cable provided with the unit only. If necessary, this connection could be made by means of a cable of up to 250 meters, using a continuous **CAT5E shielded** (FTP) cable (or better) and checking that the **shield** is connected to the connectors case.

The example shows the connection diagram of AEQ FORUM LITE console. The data and power supply output from "core" must be **always** connected to the **left RJ45** connector of control and monitoring module (rear view). The first 4 faders module is also connected by means of the same type of cable from the right RJ45 connector of control and monitoring module to the left RJ45 connector of 4 faders module (rear view). The following 4 faders modules will be connected from the right RJ45 connector of a 4 faders module to the left RJ45 connector of the following 4 faders module (rear view).

1.2. Specifications.

1.2.1. General morphology.

- Ultra-compact design split in control surface and associated audio core.
- Control surface with 4 physical faders (100mm) modules.
- Core: 2U 19" chassis including audio inputs and outputs, processing, power supply and internal equipment control hardware. Optional modules for redundant power supply, double telephone hybrid and multi-channel MADI, all of them easy to install and maintain.

1.2.2. Functionality.

- Cough mute, studio and control room ON-AIR signalling, faderstart, remote PFL, talk-back, automatic speaker mute.
- N-1 output configuration.
- Control of integrated external equipment (AEQ hybrids and codecs) and internal hybrids via programmable key section.
- Optional pre-fader / post-fader routing depending on the used buses.
- Control communication via 10/100 Ethernet connection using TCP/IP protocol.
- Boot-up using last used settings.
- System input signals can be assigned to any control channel.
- System settings are stored in the on-board memory: up to 10 available memory positions.

1.2.3. General features.

- All system signals configurable for monitoring in Control, Studio, CUE Headphones and VU-meters.
- 4 direct routing buttons on each channel.
- Silent operation by convection cooling. AEQ FORUM LITE is ideally suited for self-operated applications.
- Talk-back function assigned to microphone 4, with 4 PTT buttons for direct intercom.
- 2 built-in headphone outputs. In addition, a stereo line output can be assigned for secondary headphones.
- 2 precision stereo VU meters.
- Test tone (1KHz) generator.
- Externally synchronized clock, timer and stopwatch.
- Electronically balanced microphone inputs with selectable micro or line level and Phantom power.
- Electronically balanced analog line inputs and outputs.
- Transformer balanced digital inputs and outputs.
- Sampling rate converters for the digital inputs.
- Redundant power supply (optional).
- The data and power supply connection from core to control surface is made by means of a supplied straight Ethernet cable that carries proprietary **power supply**. If necessary, this connection could be made by means of a cable of up to 250 meters, using a continuous **CAT5E shielded** (FTP) cable (or better) and checking that the **shield** is connected to the connectors case.

1.2.4. Standard Inputs and Outputs.

- 4 mic/line mono inputs.
- 2 USB digital stereo inputs/outputs.
- 4 AES/EBU digital stereo inputs/outputs that can be configured as SPDIF.
- 12 analog mono inputs / 8 analog mono outputs (that can be configured as individual stereo pairs).
- Bi-directional AoIP (audio over IP) interface handling up to 32 mono inputs and outputs.

- Analog stereo outputs for Control, Studio, CUE and Studio primary Headphone monitoring.
- Analog stereo amplified output for Control Headphones, jack 1/4".
- 8 opto-coupled GPI's, 8 opto-coupled GPO's and 4 GPO's with relays.

1.2.5. Optional Inputs and Outputs.

- Dual line Digital Telephone Hybrid with two RJ-11 Line connectors and two RJ-11 connectors for Telephone SET.
- Bi-directional MAD1 fiber-optic interface handling up to 64 digital inputs and outputs.
IMPORTANT NOTE: MAD1 functionality is not compatible with AoIP (audio over IP) functionality, both options can't be active at the same time.

1.2.6. System processing capacity.

- 48 kHz, 24 bit internal sampling frequency.
- ± 12 dB gain control (analog and digital line inputs and outputs signals - including signals not visible on control surface).
- Gain control for microphone inputs: from -36 to +19dB.
- Selectable balance/panoramic control on all channels.
- Selective phase reverse.
- Audio processing for 16 stereo signals (up to 8 on fader plus 8 signals not visible on control surface).
- Pre-defined audio processing that allows manual adjustment.
- Available audio effects: 3 bands equalizer with adjustable Q value, high pass and low pass filters, compressor/limiter and noise gate.

2. PHYSICAL DESCRIPTION OF THE UNIT.

AEQ FORUM LITE is an ultra-compact digital mixing console consisting in a control surface and associated audio engine. These two functional blocks, the control surface (where all the controls and status indicators are located) and the audio engine or core unit (where all the audio inputs/outputs, routing, sum and processing electronics is included), are connected together with a data and power supply proprietary link with RJ45 connectors.

These functional blocks will be separately described hereunder.

2.1. Description of the control surface.

The control surface is the operators "work" area of the AEQ FORUM LITE. All operational organization, management and implementation of the audio program are accomplished from this area. The control surface incorporates all the keys, displays, faders, encoders and VU meters required to operate the equipment

There are two different areas on the AEQ FORUM LITE control surface: the area that corresponds to the audio channels controlled through faders (each module includes 4 faders) and the "CONTROL AND MONITORING MODULE" which is normally located to the right.



2.1.1. Channels.

The **AEQ FORUM LITE** control surface consists of modules with 4 independent channels, each one featuring its own dedicated 100mm fader.

The assignment of signals to channel faders on the AEQ FORUM LITE is completely user definable. It is possible to assign any signal to any channel fader at any time. This allows for the re-distribution channels to adapt to different programs or operators.

In addition, different channel assignment of signals can be stored in memory to be used by different users or applications.

In addition to the signals on channel faders present on the control surface that can be mixed, processed and sent to any output channel, AEQ FORUM LITE is capable of routing and adjusting the levels for other hidden signals. Up to a total of 94x96 audio signals can be routed.



Located in the upper part of the channel are 4 routing keys ("PROGRAM", "AUDITION", "AUX1" and "AUX 2") and a "SELECT" button to assign the channel to advanced settings common control (gain, dynamics, EQ and balance). By means of a long press (more than 2 seconds), the "SELECT" key provides quick access to the signal selection on the fader.

Beneath this section, an OLED display shows channel name and status for balance or pan. Immediately under the display is located the Pre-listen button "CUE", 4 status indicators LEDs that alerts with regards to the activation of equalization ("EQ"), dynamics ("DYN"), balance ("BAL") and gain ("GAIN"). Also in this section, a luminous label indicating that the channel is activated and is sending signal to the output buses ("ON AIR").

By pressing the "SELECT" button the advanced configuration functions are enabled. These configurations are accomplished within the integrated multifunction display in the control and monitoring section at the far right of the control surface. Its operation is based on rotary encoders and graphical menus and short-cut function keys, depending on the information shown on screen.



Among the general functions are the instant activation and adjustment of audio effects (EQ, filters, limiters, etc.), configurations and memories management, disconnection of applied effects, phase change, inserting of a test signal, as well as clock, timer and stopwatch for timing control, etc. For more information see chapter **"3. DESCRIPTION OF THE INTERNAL MENU"** of this manual.

The channel module is completed with the sliding fader and the Channel ON and OFF buttons.

2.1.1.1. Routing keys.

There are four keys on the top of the channel that routes the channel signal to the corresponding output bus. Activation is indicated through the integrated LEDs in each of these keys, and indicates the creation of a cross point between the input signal on the channel and the output channel corresponding to the key.



Detail of routing keys

From left to right and top to bottom, the four keys of direct routing are "**PROGRAM**" (sending to master 1), "**AUDITION**" (sending to master 2), "**AUX1**" (sending to auxiliary 1) y "**AUX2**" (sending to auxiliary 2). The allocation of physical outputs associated with these signals and the physical circuits of the inputs/outputs modules on the back of AEQ FORUM LITE is accomplished from the configuration software. For more information, please refer to chapter "**4. CONFIGURATION SOFTWARE**" of this manual.

2.1.1.2. SELECT.

The control surface of AEQ FORUM LITE offers the usual controls for a mixing console on each channel, but AEQ FORUM LITE also offers a wide range of possibilities for routing and processing, beyond the physical options included in each channel. These possibilities have been distributed in a logical manner within internal menus accessible from the main screen of the Control and Monitoring section.

The operation is intuitive, always beginning with pressing the "SELECT" button on the channel that you want to process and moving to the main screen of the Control and Monitoring section of the console to accomplish the activations or adjustments. For further details please refer to section 3.4.3.1 of this manual.

By means of a long press (more than 2 seconds), the "SELECT" key provides quick access to the signal selection on the fader. See section 3.4.3.1.3.2 of this manual.

2.1.1.3. Channel display.

Each one of the channels on the AEQ FORUM LITE integrates a two-colour OLED display showing:

- Name of the associated audio signal (maximum 6 characters, editable via the configuration software). For more information see chapter "4. CONFIGURATION SOFTWARE" of this manual.
- Status of balance between left (L) and right signal (R) in stereo signals (or panoramic for monophonic signals).



NOTE: For firmware version 2.03 of FSC (or 1.14 for earlier editions of the board) or higher, the order of this information changes, with the signal name appearing below and the status of balance or panoramic above. In addition, when the surface enters low lighting mode (after remaining about 5 minutes without being used), a lateral scroll of that information starts in order to protect the lifetime of the displays (that scroll can be deactivated: see section 4.2.8 of this manual).

2.1.1.4. CUE.

This button allows you to activate a pre-fader listening to the audio channel for monitoring and control. When activated the integrated LED is lit. It is possible to send the audio signals of several channels to the CUE bus, acting as a summing bus. There is a type of programmable keys ("Auto Cue") that allows you to modify the working mode of these keys (see section 4.3.2.10 of this manual).

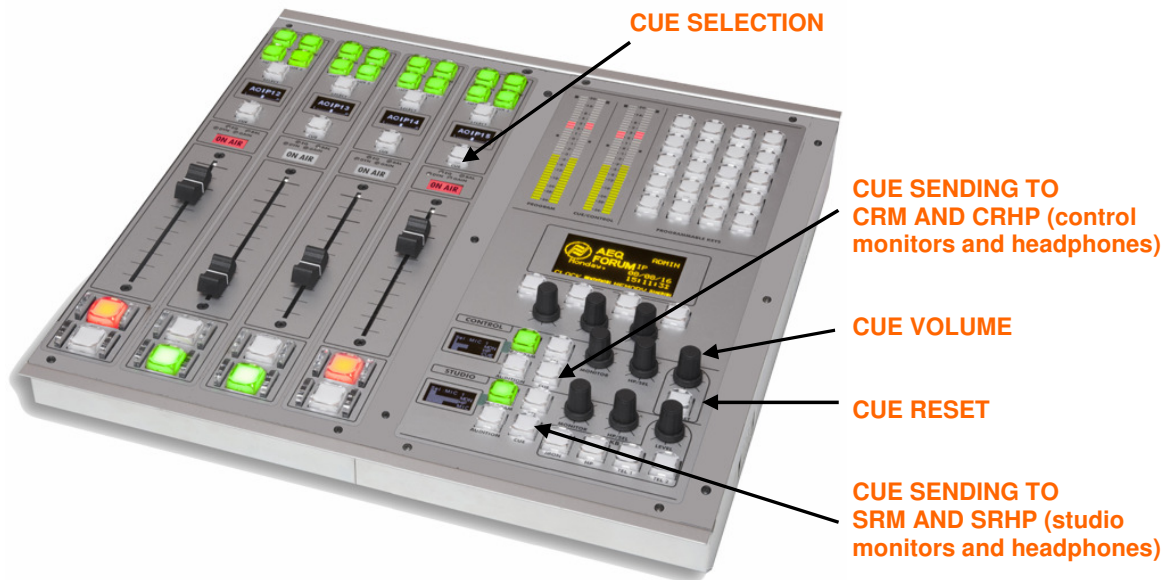

CUE signal associated controls

The encoder of CUE volume control and the "CUE RESET" key (that disconnects all active signals sent to the CUE bus and turns off the corresponding CUE buttons) are placed in the Control and Monitoring zone. There is also the option of setting one of the programmable keys as "CUE RESET" key (see section 4.3.2.6 of this manual).

A dedicated stereo output for a set of external active speakers is provided in the "CUE" connector (a 1/8" or 3,5mm stereo minijack), at the back of the AEQ FORUM LITE audio core. It is compatible with most PC speakers.

2.1.1.5. Active processes indicator.

Under the "CUE" button there are four yellow LEDs with corresponding labels, from left to right and top to bottom, "EQ" (equalizer), "BAL" (balance), "DYN" (dynamic processor) and "GAIN". The lit status indicates the activation of any of the four processes previously mentioned in a certain fader channel.



These four processes (EQ, dynamics, balance and gain) are controlled from the internal menu associated with the "SELECT" button on the main screen of the Control and Monitoring section.

2.1.1.6. ON AIR LED.

Under the lights of active processes is located the "ON AIR" warning light. This light is ON when the audio signal present at the input of the channel is sent to any of the outputs previously described (see section 3.4.3.1.3.2 of this manual).

For this, two conditions must be met simultaneously:

- Channel fader is located in any position except at minimum of travel of the fader.
- Channel ON key is activated.



There is a certain working mode in which this indicator may blink: see section 4.2.8 of this manual.

2.1.1.7. Fader.

100mm. fader. The fader travel is printed with 11 bands, the maximum output level +22dB corresponding to the last, and the third band from above to +0dB or nominal operating level. Both of these marks are differentiated in size from the rest.

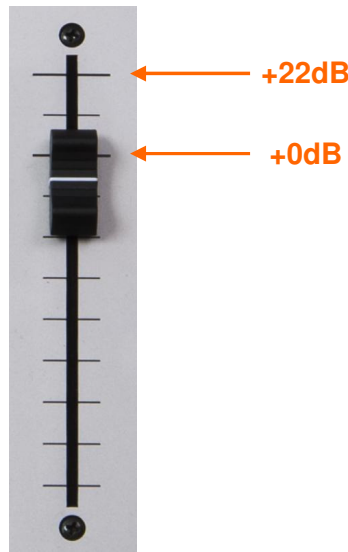

Detail of 100mm fader calibration

There is an option in the configuration software ("**Fader Mode**") that allows you to modify the position of that nominal operating level (see section 4.2.1 of this manual).

The response mode of the fader is logarithmic, producing great attenuation of the level at the bottom of the fader travel and less adjustment at the top.

The bottom position of the fader travel, triggers gain $-\infty$ dB or absence of signal, which is also reflected in the channel "ON AIR" indicator (it turns off).

2.1.1.8. Channel activation keys.

The channel activation keys, "CHANNEL ON/OFF", enable or disable the sending of the audio signal present at the channel input to the outputs previously defined. If the sliding fader is located in any position of the fader travel other than the minimum, the channel on or off activation will be reflected through the "ON AIR" indicator previously described.

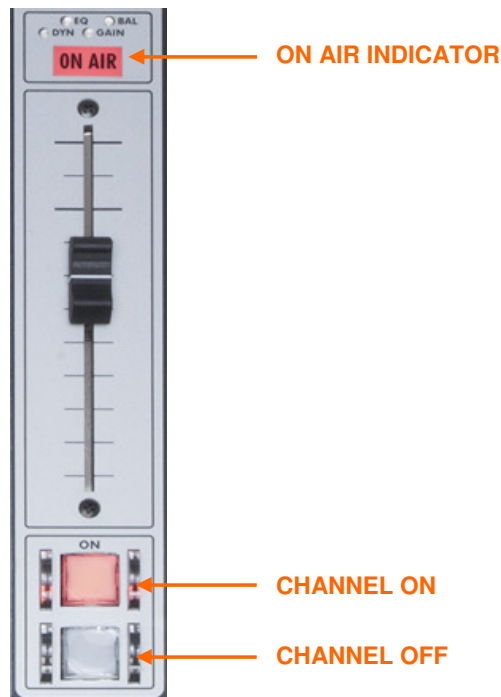

The **upper** key is associated with **ON** function and has a red light built in and the **lower** key is associated with **OFF** function and has a yellow light. The operation is exclusive, both keys can not be turned on simultaneously. This is the **NORMAL** working mode.

As indicated below in section 3.3, when a new configuration memory or snapshot is loaded, the audio of the activated channel or channels (ON AIR) will not be interrupted (and the associated routing will remain) provided that in the new memory those channels are placed in the same fader positions. When the option "**Snapshot: Blink when the signal has not been loaded**" is also activated in the configuration (see section 4.2.8 of this manual), the **upper activation key** of those activated channels will start blinking to indicate that they keep the previous configuration.

There are 3 additional working modes for the channel activation keys that can be activated in the corresponding configuration memory or snapshot. In these modes, the **upper** key is associated with **ON/OFF** function and the **lower** key works as follows:

- **ORDERS:** when you press and keep pressed the key you send the orders microphone to the output channel associated with the input present at the channel (Talkback functionality).
- **A/B:** if you press the key for more than 500 ms, when you release it a fast change of the input assigned to the channel is accomplished (it is shown in the channel display).
- **GPO:** when you press and keep pressed the key you activate the physical or virtual GPO output associated with the input present at the channel (the GPO is deactivated when you release the key).

For more information about these modes, see section 4.3.5 of this manual.

These keys can be activated remotely by GPI. To configure remote activation, see section 4.2.3.1 of this manual.

2.1.2. Control and monitoring section.

The control and monitoring section (C&M) of the control surface is usually located to the right. This section enables the overall management of the signals on the system, including routing and control processes, as well as monitoring of the signals used in developing the final program, by means of the VU-Meters, and CUE control.

This control and monitoring section is divided into four main areas:

- **Control VU meters:** allows you to monitor visually the level of the audio signals from the master output and the CUE bus (or the control monitoring bus, when there are no channels sent to CUE).
- **Programmable keys:** dedicated buttons with special functions defined through the configuration software.
- **Main screen:** it displays the internal menus. This section also incorporates contextual keys and encoders.
- **Studio, Control and Talk-back monitoring:** where you can manage the audio signals sent to the headphones and speakers, for the control room and the studio room, as well as the talk-back functions for the intercom for both areas.

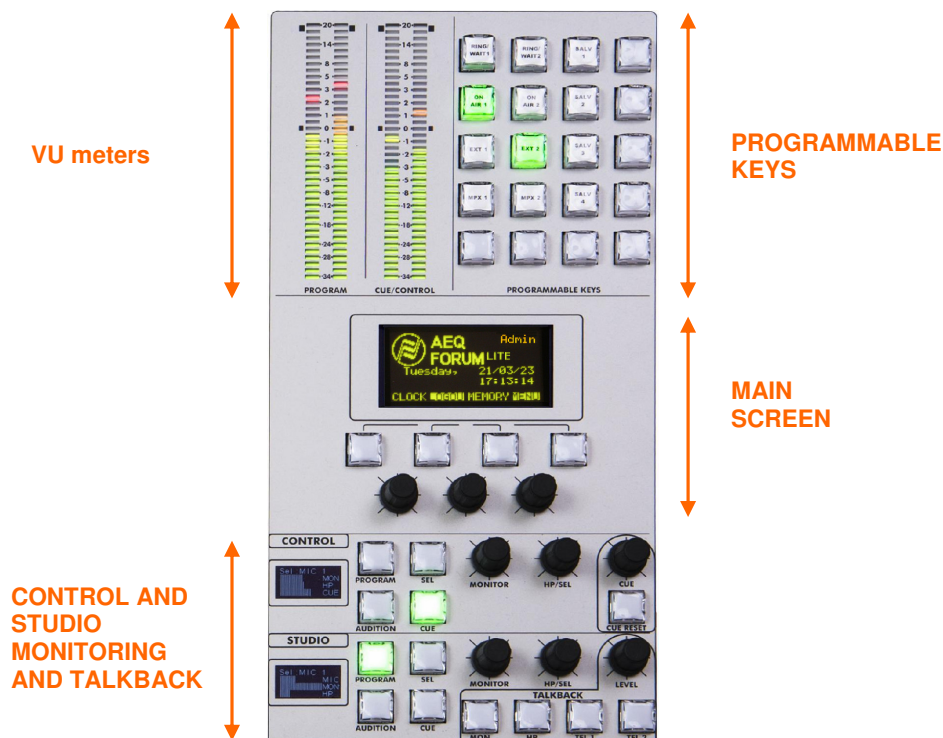

2.1.2.1. Control VU meters.

There are two 40 segment LED stereo VU meters. The left one shows the **Program** output and the right one the **CUE** bus (or the **control monitoring** bus, when there are no channels sent to CUE).

From bottom to top, the first 25 LEDs are green, followed by an area of 5 yellow LEDs to finish with an area of 10 red LEDs. 0dB point or nominal value corresponds to the first yellow LED adjacent to the last green LED.

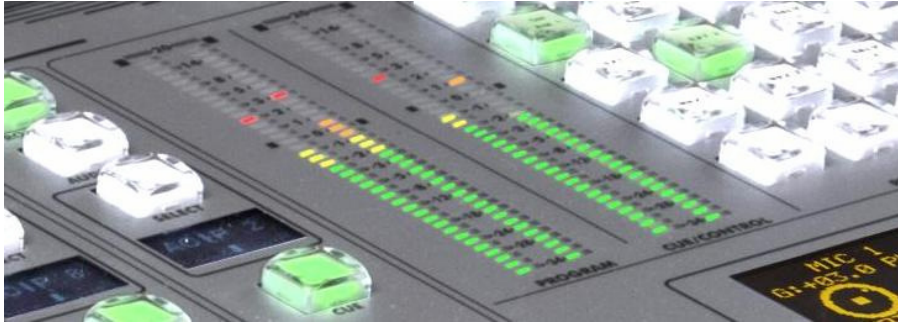

Detail of control vumeters

Both VU meters are set to function as IEC268-10: 5ms/-2dB (vu-meter only) and the peak-meter IEC268-17: 300 ms (vu-meter & Flying PPM) superimposed.

2.1.2.2. Programmable keys.

The Control and Monitoring area of the AEQ FORUM LITE includes 20 programmable keys in 5 rows of 4 columns.

These programmable keys can be configured through software to perform specific functions such as salvos, GPI, GPO, external codecs control. For more information see section 4.3.2 of this manual.



The operation of the programmable keys contemplates two modes:

- **NORMAL:** the pressing of the key triggers the execution of the programmed action. Pressing it again will produce the end of the previously launched action, or in the case of SALVOS, even the opposite action or disconnection of the SALVO.
- **PTT (PUSH-TO-TALK):** the pressing of the key will trigger the execution of the programmed action but only remains active as long as you keep the button pressed.

All keys can be easily labelled, removing the transparent plastic cover and inserting a text label. AEQ supplies with the equipment a template that allows you to create these labels on clear acetate or plain paper.

2.1.2.3. Main display.

The main screen is a two coloured OLED (yellow/black) 128x64 pixel resolution display that shows the entire internal advanced menu of the AEQ FORUM LITE. For more information see section "3. DESCRIPTION OF THE INTERNAL MENU" of this manual.

To simplify operations on the internal menu shown on this display there are four short-cut keys and three associated rotary encoders. Depending on the information there shown on the last line of the menu display visible on the main display, these short-cut keys will have a function or another.

At most, the last line will have four menu options visible from left to right, and they are directly associated with short-cut keys from left to right.



The three rotary encoders are related to the remaining lines of the menu. Each display is described in chapter 3 of this manual but the thumb-rule for the association of the rotary encoder to the visible functions is: option visible to the left or in the upper part of the menu is controlled from the encoder located to the left. In many cases the encoders are represented and labelled on the display for easy operation.

NOTE: For firmware version 3.90 of MSC (or 2.90 for previous edition of the board) or higher, after remaining about 5 minutes without being used, the display enters low lighting mode in order to protect its lifetime.

2.1.2.4. Control room monitoring section.

Located in the lower right corner of the AEQ FORUM LITE control surface are a two-coloured display, three rotary encoders and five keys (one of them, "SEL", a short-cut key).

- In the two-coloured OLED display are shown the output levels for the control monitoring signals and the selected sources in each case, for control headset, control speakers and CUE.

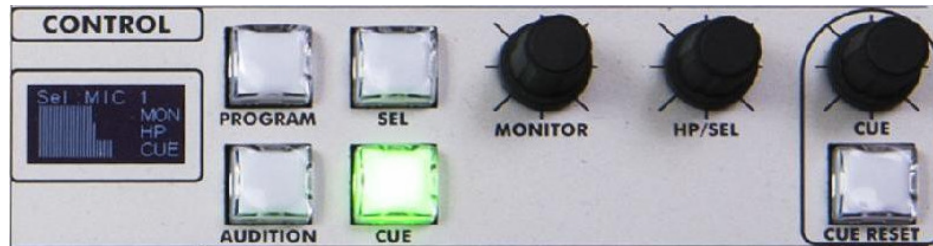

NOTE: For firmware version 3.90 of MSC (or 2.90 for previous edition of the board) or higher, when the surface enters low lighting mode (after remaining about 5 minutes without being used), a lateral scroll of that information starts in order to protect the lifetime of the display (that scroll can be deactivated: see section 4.2.8 of this manual).

- The three rotary encoders, from left to right, are:
 - **"MONITOR"**: it controls the audio level for the physical output for the control room monitors. To decrease the level turn the encoder to the left. To increase the level turn the encoder to the right.
 - **"HP/SOURCE"**: it controls the audio level for the physical output for the control headphones. To decrease the level turn the encoder to the left. To increase the level turn the encoder to the right. This encoder can also be used to select the signal to monitor associated with the key "SEL": press to access a list of signals, and turn the encoder to move up or down in the list of signals; pushing the encoder a second time confirms the selection of the highlighted signal.



- **"CUE"**: it controls the audio level of the CUE output. To decrease the level turn the encoder to the left. To increase the level, turn the encoder to the right.
- The four keys at the right of the display allows to select the signal to monitor on control speakers and headset:
 - **"PROGRAM"**: allows you to monitor the audio signal **Program**.
 - **"AUDITION"**: allows you to monitor the audio signal **Audition**.
 - **"SEL"**: allows you to monitor any signal of the console previously selected by means of "HP/SOURCE" encoder.
 - **"CUE"**: allows you to monitor the audio signal present on the CUE bus.

These four keys can have two working modes that are selected from the Configuration Software (see section 4.2.4 of this manual):

- **"Mixer"**: each key pressed adds the signal to be monitored to the summing bus.
- **"Exclusive"**: each key pressed connects the signal to the summing bus and disconnects any signal previously selected.

In case there are no channels sent to CUE, the signal or signals selected in this section will be shown in the right control VU meter (see section 2.1.2.1 of this manual).

There is a type of programmable key ("**Auto Cue**") that allows you to modify the working mode of this section (see section 4.3.2.10 of this manual).

- The **"CUE RESET"** key allows to disconnect all active signals sent to the CUE bus and turn off the "CUE" buttons activated on the corresponding channels. There is also the option of setting one of the programmable keys as "CUE RESET" key (see section 4.3.2.6 of this manual).

2.1.2.5. Studio room monitoring and Talkback sections.

Located under control room monitoring section, in the lower left corner of the AEQ FORUM LITE control surface, are a two-coloured display, three rotary encoders and eight keys (one of them, "SEL", a short-cut key).

- In the two-coloured OLED display are shown the output levels for the studio monitoring signals and the selected sources in each case, for studio headset, studio speakers and talkback.

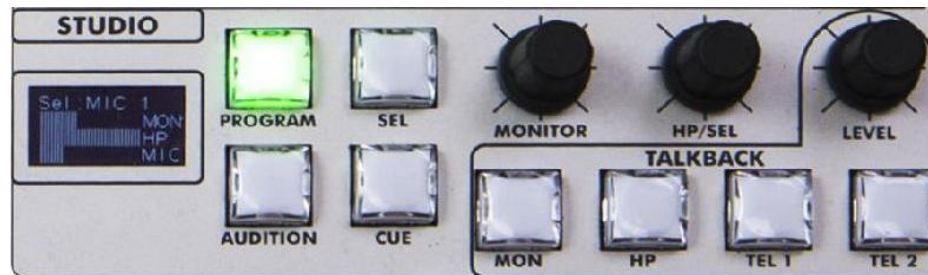

NOTE: For firmware version 3.90 of MSC (or 2.90 for previous edition of the board) or higher, when the surface enters low lighting mode (after remaining about 5 minutes without being used), a lateral scroll of that information starts in order to protect the lifetime of the display (that scroll can be deactivated: see section 4.2.8 of this manual).

- The three rotary encoders, from left to right, are:
 - **"MONITOR"**: it controls the audio level for the physical output for the studio room monitors. To decrease the level, turn the encoder to the left. To increase the level, turn the encoder to the right.
 - **"HP/SOURCE"**: it controls the audio level for the physical output for the studio headphones. To decrease the level, turn the encoder to the left. To increase the level, turn the encoder to the right. This encoder can also be used to select the signal to monitor associated with the key "SEL": press to access a list of signals, and turn the encoder to move up or down in the list of signals; pushing the encoder a second time confirms the selection of the highlighted signal.
 - **"LEVEL"** (Talkback Level): it controls the gain of the TALKBACK microphone. To decrease the level, turn the encoder to the left. To increase the level, turn the encoder to the right.

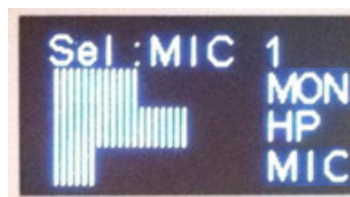

- The four keys at the right of the display allows to select the signal to monitor on studio speakers and headset:
 - **"PROGRAM"**: allows you to monitor the audio signal **Program**.
 - **"AUDITION"**: allows you to monitor the audio signal **Audition**.
 - **"SEL"**: allows you to monitor any signal of the console previously selected by means of the "HP/SOURCE" encoder.
 - **"CUE"**: allows you to monitor the audio signal present on the CUE bus.

These four keys can have two working modes that are selected from the Configuration Software (see section 4.2.4 of this manual):

- **"Mixer"**: each key pressed adds the signal to be monitored to the summing bus.

- **"Exclusive"**: each key pressed connects the signal to the summing bus and disconnects any signal previously selected.
- The four keys under the encoders, besides the "LEVEL" encoder, make up the **Talkback** section. This section allows the console operator to communicate directly with the studio and remote guests (lines).

The default intercom channels for the AEQ FORUM LITE are established between the control room and the studio with separate channels for monitors and headphones. You can set additional channels of intercom to facilitate communications. For example, talk-back can be established between studio or control to the different audio returns to hybrids or audiodcodecs. The talk-back microphone can also be used as an auto-control microphone if so defined.



The talk-back section of the control surface consists of these 4 key buttons, working along with the volume adjusted by means of the "LEVEL" (Talkback Level) encoder.

From left to right are:

- **"MON"**: talk-back to studio monitors.
- **"HP"**: talk-back to studio headphones. The default configuration of the AEQ FORUM LITE does not differentiate between primary and secondary headphones. It is possible to establish a secondary group of headphone creating a salvo to be triggered from the programmable keys.
- **"TEL 1"**: talk-back to the telephone hybrid line 1 (AEQ FORUM can work with an optional 2 lines digital hybrid module, but has 10 MPX internal buses hidden that can be used with dedicated lines, external audiodcodecs or telephone hybrids. The talk-back to dedicated lines, external audiodcodecs or telephone hybrids can be established through the use of the programmable keys).
- **"TEL 2"**: talk-back to the telephone hybrid line 2.

2.2. Audio engine description.

AEQ FORUM LITE is an ultra-compact digital audio mixer for Radio and Television consisting in a control surface and an associated audio engine, specially designed for ON AIR broadcast control, highly adaptable to different operational situations. The following chapters will describe AEQ FORUM LITE audio engine.

The AEQ FORUM LITE audio engine or core unit consists in a 2RU chassis (89mm or 3 1/2" height), designed to be installed in standardized 19" (482mm) racks. As with the rest of AEQ FORUM LITE, the audio engine size has been minimized without leaving any feature out, its depth being only 330mm.

AEQ FORUM LITE audio engine does not have any fans or moving mechanical parts for cooling. Therefore its operation is totally silent and can thus be installed inside radio studios. The unit cooling relies on convection air flow. For this reason it is strongly recommended to leave some space above and below the equipment. It also takes advantage of the good thermal conductivity properties of the metal elements of the chassis to channel the residual heat to the front panel, where it is dissipated.

IMPORTANT NOTE: There is a new edition of audio core, called **MCORE**, with a new front panel and with some modifications with respect to the previous "Core". On one hand, the connector associated to data and power supply output towards control surface has changed (see section 2.2.1 of this manual). On the other hand, the digital inputs and outputs configuration as AES/EBU or SPDIF and the MIC/LINE inputs configuration as microphone or line, as well as the Phantom power activation for those microphone inputs, will be no longer accomplished by means of jumpers (see sections 2.2.3.1, 2.2.3.2, 2.2.3.3, 2.2.3.6, 3.4.3.1.3.1 and 4.3.5.1 of this manual).

Ease of installation and set up been a priority during the design of FORUM LITE, so audio input and output, control monitoring and auxiliary signals configurations of the mixing console are fixed and defined from Factory:

- 4 balanced microphone / line level inputs.
- 12 line level balanced mono analog inputs.
- 4 AES/S/PDIF digital stereo inputs.
- 8 line level balanced mono analog outputs.
- 4 AES/S/PDIF digital stereo outputs.
- 2 stereo input/output USB computer connections.
- Bi-directional AoIP (audio over IP) interface handling up to 32 mono inputs and outputs.
- Control and Studio headphone outputs.
- Stereo unbalanced CUE output with line level.
- Stereo balanced analog outputs with line level for control and Studio monitors.

In order to connect external cough-cuts, remote control external devices, ON AIR lights, etc, AEQ FORUM LITE features 8 general purpose digital inputs (GPI), 8 outputs (GPO) and another 4 relay-switched outputs. The system configuration and remote control is carried out through an IP based Ethernet connection.

AEQ FORUM LITE also features 246 **virtual** GPIs and 242 **virtual** GPOs; these virtual GPIs and GPOs are general purpose inputs and outputs that are respectively related to virtual GPOs and GPIs of other units through an IP network, so the control is carried through the IP network between different units.



AEQ FORUM LITE has an optional bi-directional MADi interface that can carry up to 64 digital inputs and outputs (MADi functionality is not compatible with AoIP functionality, both options can't be active at the same time); there is also an optional Dual line Digital Telephone Hybrid.

For ease of wiring and avoid errors in the installation process, audio and data cables with DB15 male connectors required to connect the console can be optionally supplied. In any event, it is necessary to use shielded and balanced audio cables and that the connection to the DB connectors are made by technically qualified personnel and properly verified before connecting the equipment. Further, optional power supply and wiring for control and studio signalling and GPIO can be supplied.



2.2.1. Power supply.

The power supply module is located at the left of the audio engine back panel (as seen from the rear). It supplies the internal voltages to the console and to the control surface. It consists on a universal auto-range switching power supply that can operate with worldwide mains: 90 - 132 V AC & 187 – 264 V AC, 47/63Hz. The max power consumption is 65VA.

Optionally, a second (backup) power supply can be installed in order to have redundancy. This second power supply includes installation instructions. If two power supplies are used, it is recommended that one of them is connected to a UPS while the other can be connected to regular mains or domestic power.



The console/engine data and power supply interconnection is located at the right of the power supply inputs. It is designed for use with straight Ethernet cabling, but also carries proprietary **power supply lines**. Please use the cable provided with the unit only. If necessary, this connection could be made by means of a cable of up to 250 meters, using a continuous CAT5E shielded (FTP) cable (or better) and checking that the shield is connected to the connectors case.

In the case of the core edition called **MCORE** this connector is an RJ45 XLR type (please use the cable provided with the unit):



IMPORTANT NOTE: Do not connect this output to any device but the control and monitoring module (there is a severe risk of damage to other equipment or even the audio engine itself). In order to avoid any damage to the unit is **VERY IMPORTANT** to turn off the unit before connecting or disconnecting this cable.



The audio output for **CUE** or prelisten is also located in this area. See section 2.2.2.4 in this manual.

2.2.2. Auxiliary connections.

This area of the AEQ FORUM LITE back panel includes a wide variety of inputs and outputs, required to integrate the unit with any professional audio installation, including several headphone and external speaker outputs, general purpose inputs and outputs, control and studio speakers.

Among these auxiliary console inputs and outputs, you can find not only analog signals such as headphones, speakers or CUE, but also physical general purpose inputs and outputs GPIOs (both open-collector and relay switched), virtual GPIOs over IP network, and finally the control and configuration interfaces with an external computer running the associated setup and remote control software.

2.2.2.1. GPIO.

AEQ FORUM LITE includes many general purpose inputs and outputs using optocouplers and relay contacts, all of them made available at the back panel of the audio engine.



2.2.2.1.1. Opto-coupled GPI.

AEQ FORUM LITE includes 8 electronic input interfaces of opto-coupled or open collector type - GPIs - through the female DB15 connector labelled "**GP INPUTS**".

Specifications:

- Opto-coupler protected inputs (TLP127).
- Maximum Input Current: 50mA.
- Applicable voltage: from 5V to 24V.

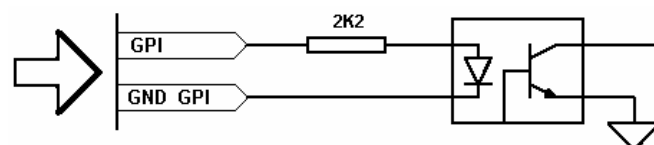

Associated electronic with opto-coupled GPI

In order to make installation process easier, AEQ offers specific pre-fabricated cable kits for AEQ FORUM LITE data input/output within the optional modules range: CP CAB GPIO, consisting in a male DB15 connector soldered to a 6 meters long cable with no connectors at the other end. For more information please check section 2.2.5 of this manual.

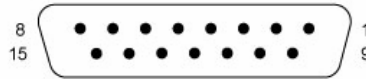

GPI Inputs (SUB-D female, 15 pins):

Pin	Signal	Pin	Signal
1	GPI1	9	GND_GPI1-4
2	GPI2	10	GND_GPI1-4
3	GPI3	11	GND_GPI1-4
4	GPI4	12	Not connected
5	GPI5	13	GND_GPI5-8
6	GPI6	14	GND_GPI5-8
7	GPI7	15	GND_GPI5-8
8	GPI8		

Please note that there is a common ground (GND) for inputs 1 to 4 and another one for inputs 5 to 8.

Upon request, this wiring kit can be supplied with connectors as specified by the customer. For more information please refer to AEQ sales department or authorised distributors.



2.2.2.1.2. Opto-coupled GPO.

As explained, AEQ FORUM LITE also includes 8 GPO output interfaces with opto-coupler. These are located at the back of the audio engine or core unit by means of a female DB15 connector labelled "**GP OUTPUTS**".

Specifications:

- Opto-coupler protected outputs (TLP127).
- Maximum current: 80mA.
- Recommended Maximum voltage: 200V.
- Maximum power: 100mW at 40 ° C.
- Requires external power.

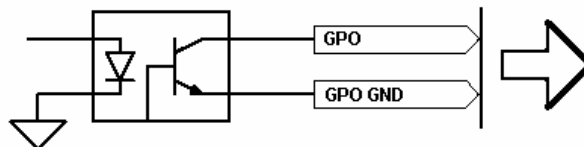

Associated electronic with opto-coupled GPO

In order to make installation process easier, AEQ offers specific pre-fabricated cable kits for AEQ FORUM LITE data input/output within the optional modules range: CP CAB GPIO, consisting in a male DB15 connector soldered to a 6 meters long cable with no connectors at the other end. For more information please check section 2.2.5 of this manual.

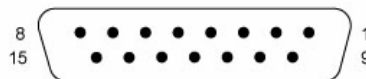

GPO Outputs (SUB-D female, 15 pins):

Pin	Signal	Pin	Signal
1	GPO1	9	GND_GPO1-4
2	GPO2	10	GND_GPO1-4
3	GPO3	11	GND_GPO1-4
4	GPO4	12	Not connected
5	GPO5	13	GND_GPO5-8
6	GPO6	14	GND_GPO5-8
7	GPO7	15	GND_GPO5-8
8	GPO8		

Please note that there is a common ground (GND) for outputs 1 to 4 and another one for outputs 5 to 8.

Upon request, this wiring kit can be supplied with connectors explicitly specified by the customer. For more information please refer to AEQ sales department or authorised distributors.



2.2.2.1.3. Physical contact GPO.

As previously stated also, AEQ FORUM LITE includes 4 GPO with relay closing contacts on the DB15 female connector labelled "**RELAYS**" at the back of the engine.

Specifications:

- Contact closure relay.
- Maximum current: 1 A @ 30 v. DC, 0.3 A @ 125 V AC.
- Maximum voltage: 60 V DC or 125 v. AC.
- Maximum power: 30 VA.

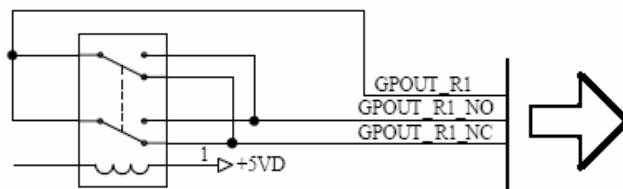

Associated electronic with physical contact GPO

In order to make installation process easier, AEQ offers specific pre-fabricated cable kits for AEQ FORUM LITE data input/output within the optional modules range: CP CAB GPIO, consisting on a DB15 male connector soldered to a 6 meters long cable with no connectors at the other end. For more information please check section 2.2.5 of this manual.

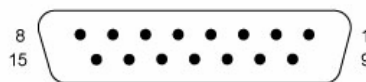

Relay GPO Outputs (SUB-D female, 15 pins):

Pin	Signal	Pin	Signal
1	GPO_RL1_NO	9	GPO_RL1
2	GPO_RL1_NC	10	Not connected
3	GPO_RL2_NO	11	GPO_RL2
4	GPO_RL2_NC	12	Not connected
5	GPO_RL3_NO	13	GPO_RL3
6	GPO_RL3_NC	14	Not connected
7	GPO_RL4_NO	15	GPO_RL4
8	GPO_RL4_NC		

NO: normally open
NC: normally close
COM: common

AEQ can upon request provide fully finished cables and in special lengths. For more information please refer to AEQ sales department or authorised distributors.

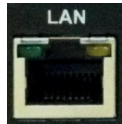

2.2.2.2. Ethernet Port.

Located in the lower left part of AEQ FORUM LITE back chassis you can find an Ethernet RJ45 10/100 Base T socket labelled "LAN" for connection to external devices using IP communications protocol.

This socket permits connection of AEQ FORUM LITE console to one or more external computers where Setup software and, in future versions, Forum Lite Virtual and/or Forum Lite Screen applications are running.

For more information please check chapter "4. CONFIGURATION SOFTWARE" in this manual.

RJ45 connector pinout is as follows:

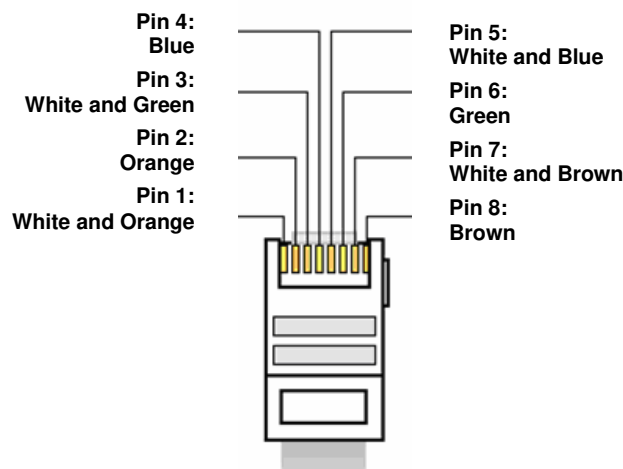

2.2.2.3. Control and studio monitors.

AEQ FORUM LITE includes line-level monitoring outputs for a pair of speakers in the control room and another pair for studio or cabin. These outputs are available through a female DB15 connector labelled "CRM & SRM".

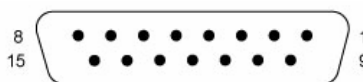

Control / Studio Monitoring Outputs (SUB-D female, 15 pins):

Pin	Signal	Pin	Signal
1	CRM L+	9	CRM L-
2	GND	10	GND
3	CRM R+	11	CRM R-
4	GND	12	GND
5	SRM L+	13	SRM L-
6	GND	14	GND
7	SRM R+	15	SRM R-
8	GND		

CRM: Control Room Monitor
 SRM: Studio Room Monitor
 L: Left
 R: Right

IMPORTANT NOTE: If you want to connect any of the outputs to an unbalanced input, you must unbalance the output, using the corresponding positive and GND pins and leaving the negative pin unconnected. Also keep in mind that unbalancing the output will reduce its level by 6dB.

In order to make installation process easier, AEQ offers specific pre-fabricated cable kits for AEQ FORUM LITE audio input/output, both analog and digital, as well as studio headphones: FR CAB INP, consisting in a male DB15 connector soldered to 4 balanced and shielded 6 meters long paired cables with no connectors at the other end, for 4 inputs or outputs. For more information please check section 2.2.5 of this manual.

AEQ can upon request provide fully finished cables and in special lengths. For more information please refer to AEQ sales department or authorised distributors.



2.2.2.4. CUE.

AEQ FORUM LITE includes a stereo line output for CUE or prelisten speakers on TRS 3,5 mm 1/8" jack, unbalanced connection. This connector (typical of self amplified PC speakers) has been chosen to simplify the selection of this component among a wide range of cost-effective solutions. **IMPORTANT:** This is not a power output, so you cannot connect speakers that are not self amplified.

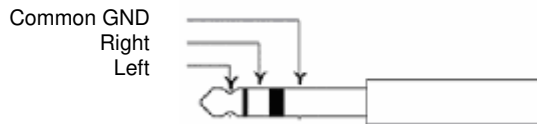

2.2.2.5. Control headphones.

AEQ FORUM LITE includes an output for a professional headphone set at the **front** of the audio engine, using a TRS 1/4" unbalanced 6,3 mm jack.

This output is labelled "**HEADPHONES**".

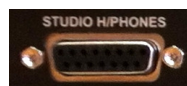
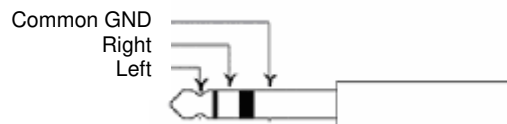

2.2.2.6. Studio headphones.

AEQ FORUM LITE features an output for Studio headphones on the DB15 female connector labelled "**STUDIO H/PHONES**".

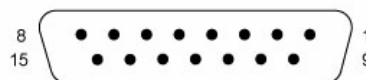

Studio Headphones Output (SUB-D female, 15 pins):

Pin	Signal	Pin	Signal
1	Not connected	9	Not connected
2	GND	10	GND
3	Not connected	11	Not connected
4	GND	12	GND
5	Active Studio Hphones Left	13	Active Studio Hphones Left
6	GND	14	GND
7	Active Studio Hphones Right	15	Active Studio Hphones Right
8	GND		

In order to use this output, connect the headphones as follows:

- For left channel, use DB15 pin 5 or 13 and connect the headphone between that point and the external shield (pin 6).
- For right channel, use DB15 pins 7 or 15 and connect the headphone between that point and the external shield (pin 6).

In order to make installation process easier, AEQ offers specific pre-fabricated cable kits for AEQ FORUM LITE audio input/output, both analog and digital, as well as studio headphones: FR CAB INP, consisting in a male DB15 connector soldered to 4 balanced and shielded 6 meters long paired cables with no connectors at the other end, for 4 inputs or outputs. For more information please check section 2.2.5 of this manual.

AEQ can upon request provide fully finished cables and in special lengths. For more information please refer to AEQ sales department or authorised distributors.

2.2.3. Generic audio inputs and outputs.

Next the available generic inputs and outputs types are detailed:

- **"AES IN"**: 4 stereo digital AES/EBU or S/PDIF inputs.
- **"AES OUT"**: 4 stereo digital AES/EBU or S/PDIF outputs.
- **"ANALOG IN"**: 12 mono line-level inputs, paired to stereo by software.
- **"ANALOG OUT"**: 8 mono line-level outputs, paired to stereo by software.
- **"MIC/LIN"**: 4 selectable line or microphone inputs.
- **"USB"**: 2 stereo USB digital audio inputs/outputs for PC.
- **"AoIP LAN"**: up to 16 (or 32, depending on hardware) mono AoIP (audio over IP) inputs and outputs, paired to stereo by software.

IMPORTANT NOTE: Regarding the wiring, the chassis of microphones must be connected to the chassis of the console frame in order to protect the microphone inputs against uncontrolled static shocks. Pin 1 (Ground) must be connected to the metal case of XLR connector in the available terminal for this purpose, so any static shock will be downloaded to ground through the frame chassis. This rule must be followed in every connector throughout the cable in case of connections by means of aerial connectors. In the same way, for AES3 or USB digital signals, the chassis of PCs or other digital audio devices must be also connected to the chassis of the console frame.

2.2.3.1. Accessing the programming jumpers.

IMPORTANT NOTE: Previous experience with installation and configuration of electronic or PC cards is required for access and reconfiguration of programming jumpers. Please don't open the unit if you don't have this experience, due to the risk of causing damages or suffering electric discharges.



AES IN inputs and **AES OUT outputs** are configured according to AES/EBU standard by default. If connection to **S/PDIF** equipment is needed, you must open the audio engine and change the corresponding jumpers. In the case of **MCORE**, there are no associated jumpers: to make this change to SPDIF, a hardware modification must be made (consult AEQ Technical Service).

Mic/Line inputs are configured for use with dynamic microphones with no phantom feed by default. If you need to connect Phantom-fed condenser microphones to these inputs or use them as mono Line inputs, you must open the audio engine and change the corresponding jumpers. In the case of **MCORE**, there are no associated jumpers: it's possible to make this change to line or activate the Phantom power from configuration software (see section 4.3.5.1 of this manual) or from the "CFG" menu in the main display of the control surface (see section 3.4.3.1.3.1 of this manual).

- **Opening the unit.**

It's **VERY IMPORTANT** to turn first the equipment off and disconnect the power supply cable(s).

Remove 10 screws located as depicted in the following photograph: 4 at the top cover, 3 at the top of the left side, 3 at the top of the right side. Pull up from the top cover and remove it.

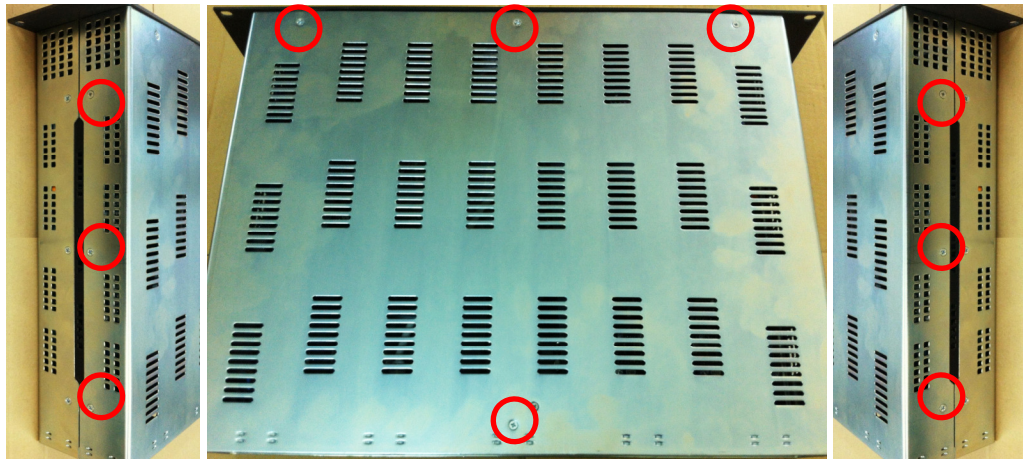

- **Finding the jumpers location.**

Place the unit with the connectors facing towards you and recognize the following zones inside it:

**DIGITAL INPUTS AND OUTPUTS
PROGRAMMING ZONE**

NOTE: When optional module **CA33** is installed, you must remove it first in order to gain access to this zone, by unscrewing 2 screws and pulling up. When re-installing, please make sure that it's correctly connected, making sure that the screw holes match and then pressing down.

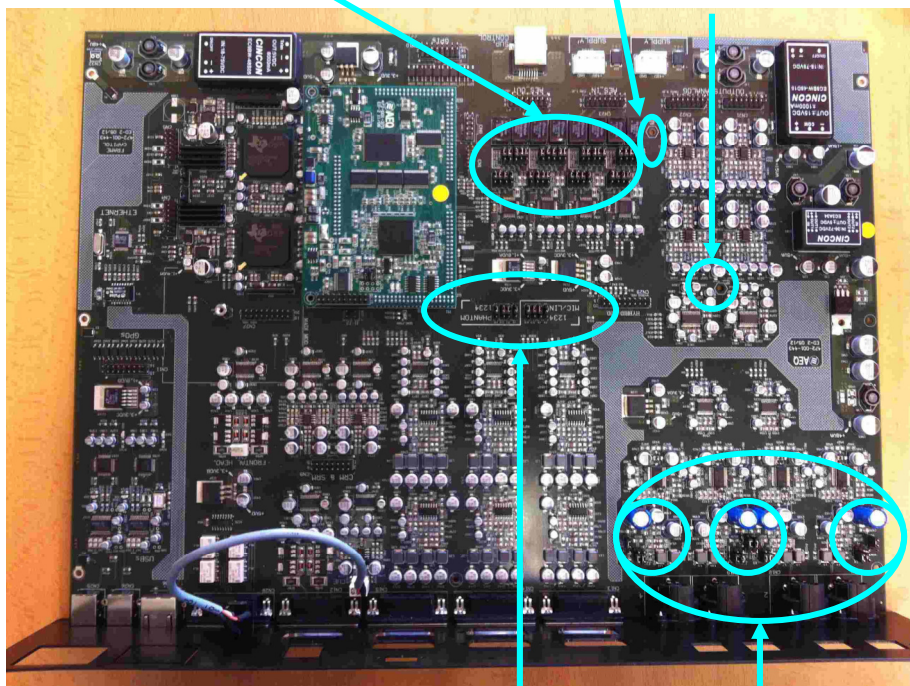

**MIC/LINE INPUTS AND PHANTOM
POWER PROGRAMMING ZONES**

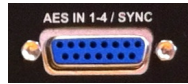

2.2.3.2. Digital inputs.

AEQ FORUM LITE includes 4 stereo balanced digital inputs available through a female DB15 connector identified as "AES IN 1-4/SYNC" configurable one by one as AES/EBU (by default) or S/PDIF by configuring the corresponding jumpers. **IMPORTANT NOTE:** In the case of **MCORE**, there are no associated jumpers: to make this change to SPDIF, a hardware modification must be made (consult AEQ Technical Service).

SRC (Sample-Rate-Converters) are included for all inputs. The digital audio format for each input is irrelevant in the process of installation and configuration since it is being managed automatically and transparently to the user.

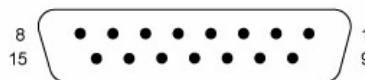

Digital Inputs (SUB-D female, 15 pins):

Pin	Signal	Pin	Signal
1	IN1+	9	IN1-
2	GND	10	GND
3	IN2+	11	IN2-
4	GND	12	GND
5	IN3+	13	IN3-
6	GND	14	GND
7	IN4+	15	IN4-
8	GND		

In order to make installation process easier, AEQ offers specific pre-fabricated cable kits for AEQ FORUM LITE audio input/output, both analog and digital, as well as studio headphones: FR CAB INP, consisting in a male DB15 connector soldered to 4 balanced and shielded 6 meters long paired cables with no connectors at the other end, for 4 inputs or outputs. For more information please check section 2.2.5 of this manual.

AEQ can upon request provide fully finished cables and in special lengths. For more information please refer to AEQ sales department or authorised distributors.

- **External synchronism connection.**

AEQ FORUM LITE features external synchronization input in AES 11 format at input 1 of the "AES IN 1-4 /SYNC" connector. That is, the console can synchronize with the external audio source connected to this input. Here we repeat the corresponding pinout:

- Pin 1: IN1+
- Pin 9: IN1-
- Pin 2: GND

- **Programming digital inputs as S/PDIF.**

In order to use S/PDIF inputs, the programming described below adapts levels and unbalance signals by joining IN1-, IN2-, IN3- and IN4- to their associated grounds, so each signal is taken from the corresponding IN+ and its GND (or IN-).

Start by following the steps detailed at section 2.2.3.1 (it's **VERY IMPORTANT** to turn first the equipment off and disconnect the power supply cable). Then, at the "DIGITAL INPUTS AND OUTPUTS PROGRAMMING ZONE", you can change the inputs one by one from AES/EBU to S/PDIF by moving the 5 jumpers associated with each input from position 1-2 (up) to position 2-3 (down), as shown in the following image:

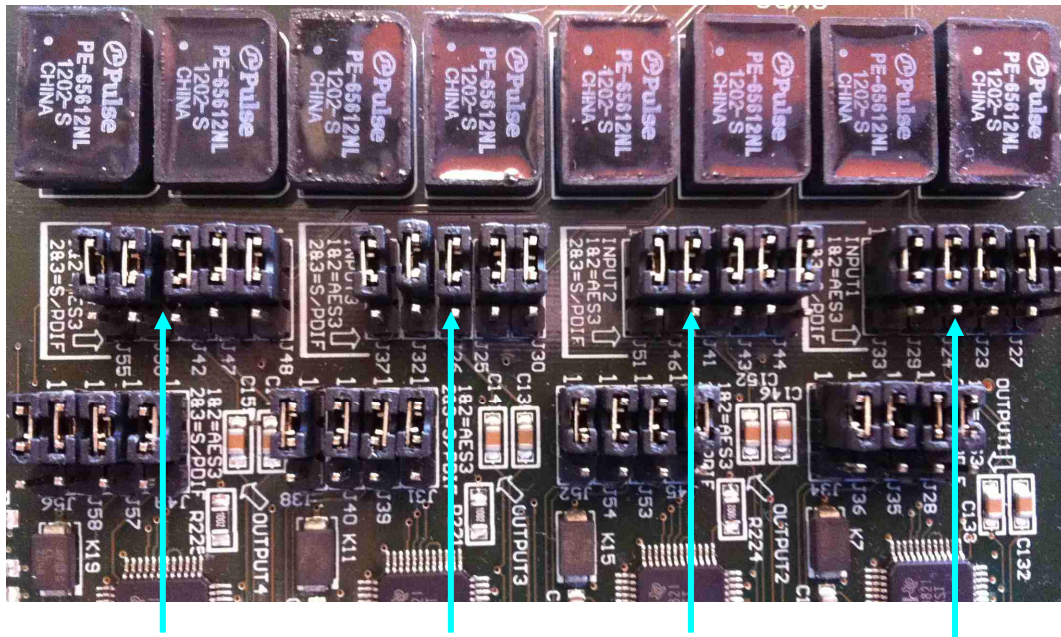

- Digital input 4**
Jumpers J42, J47, J48, J50 and J55
 - Digital input 3**
Jumpers J25, J26, J30, J32 and J37
 - Digital input 2**
Jumpers J41, J43, J44, J46 and J51
 - Digital input 1**
Jumpers J23, J24, J27, J29 and J33
- Position 1-2: AES/EBU**
Position 2-3: S/PDIF

IMPORTANT NOTE: Regarding the wiring, the chassis of microphones must be connected to the chassis of the console frame in order to protect the microphone inputs against uncontrolled static shocks. Pin 1 (Ground) must be connected to the metal case of XLR connector in the available terminal for this purpose, so any static shock will be downloaded to ground through the frame chassis. This rule must be followed in every connector throughout the cable in case of connections by means of aerial connectors. In the same way, for AES3 or USB digital signals, the chassis of PCs or other digital audio devices must be also connected to the chassis of the console frame.



2.2.3.3. Digital outputs.

AEQ FORUM LITE includes 4 stereo balanced digital outputs available through a female DB15 connector identified as "**AES OUT 1-4**" configurable one by one as AES/EBU (by default) or S/PDIF by configuring the corresponding jumpers. **IMPORTANT NOTE:** In the case of **MCORE**, there are no associated jumpers: to make this change to SPDIF, a hardware modification must be made (consult AEQ Technical Service).

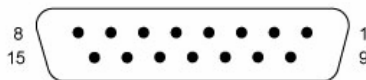

Digital Outputs (SUB-D female, 15 pins):

Pin	Signal	Pin	Signal
1	OUT1+	9	OUT1-
2	GND	10	GND
3	OUT2+	11	OUT2-
4	GND	12	GND
5	OUT3+	13	OUT3-
6	GND	14	GND
7	OUT4+	15	OUT4-
8	GND		

In order to make installation process easier, AEQ offers specific pre-fabricated cable kits for AEQ FORUM LITE audio input/output, both analog and digital, as well as studio headphones: FR CAB INP, consisting in a male DB15 connector soldered to 4 balanced and shielded 6 meters long paired cables with no connectors at the other end, for 4 inputs or outputs. For more information please check section 2.2.5 of this manual.

AEQ can upon request provide fully finished cables and in special lengths. For more information please refer to AEQ sales department or authorised distributors.

- **Programming digital outputs as S/PDIF.**

In order to provide outputs to S/PDIF equipments, the programming procedure described below adapts the levels and unbalances the signals by joining OUT1-, OUT2-, OUT3-, and OUT4- to their corresponding GND, so the signal is taken from each OUT+ to OUT- (or GND).

Start by following the steps detailed at section 2.2.3.1 (it's **VERY IMPORTANT** to turn first the equipment off and disconnect the power supply cable). Then, at the "DIGITAL INPUTS AND OUTPUTS PROGRAMMING ZONE", you can change the outputs one by one from AES/EBU to S/PDIF by moving the 4 jumpers associated with each output from position 1-2 (up) to position 2-3 (down), as shown in the following image:

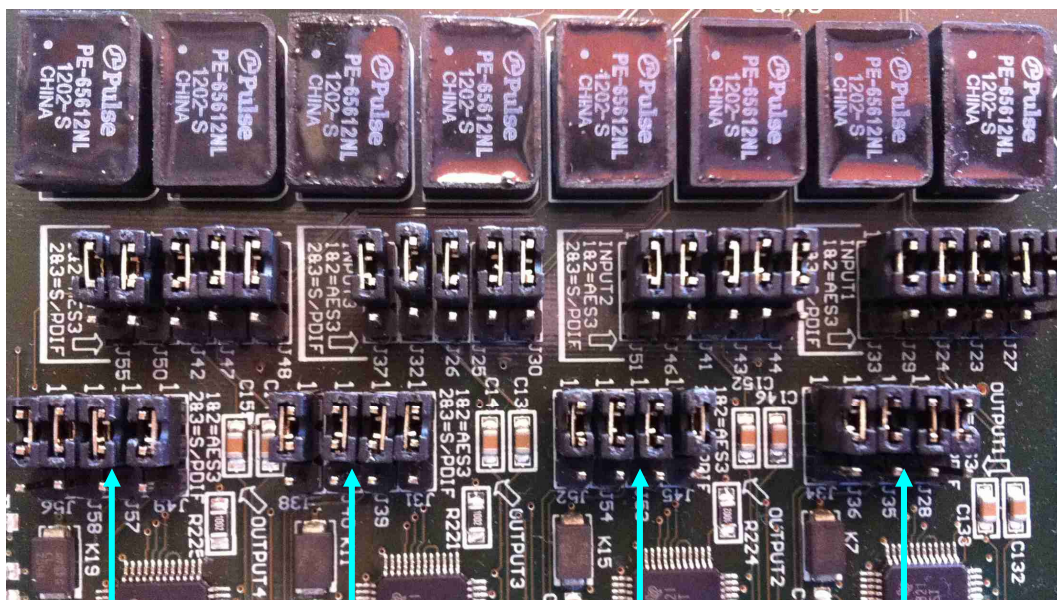

Digital output 4
Jumpers J49, J56,
J57 and J58

Digital output 3
Jumpers J31, J38,
J39 and J40

Digital output 2
Jumpers J45, J52,
J53 and J54

Digital output 1
Jumpers J28, J34,
J35 and J36

Position 1-2: AES/EBU
Position 2-3: S/PDIF

IMPORTANT NOTE: Regarding the wiring, the chassis of microphones must be connected to the chassis of the console frame in order to protect the microphone inputs against uncontrolled static shocks. Pin 1 (Ground) must be connected to the metal case of XLR connector in the available terminal for this purpose, so any static shock will be downloaded to ground through the frame chassis. This rule must be followed in every connector throughout the cable in case of connections by means of aerial connectors. In the same way, for AES3 or USB digital signals, the chassis of PCs or other digital audio devices must be also connected to the chassis of the console frame.



2.2.3.4. Analog inputs.

AEQ FORUM LITE includes 12 mono line-level inputs, electronically balanced, available through 3 female DB15 connectors identified as "**ANALOG IN 1-4**", "**ANALOG IN 5-8**" and "**ANALOG IN 9-12**".

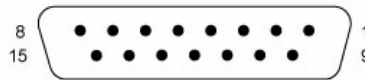

Analog Inputs (SUB-D female, 15 pins):

"ANALOG IN 1-4" connector

Pin	Signal	Pin	Signal
1	IN1+	9	IN1-
2	GND	10	GND
3	IN2+	11	IN2-
4	GND	12	GND
5	IN3+	13	IN3-
6	GND	14	GND
7	IN4+	15	IN4-
8	GND		

"ANALOG IN 5-8" connector

Pin	Signal	Pin	Signal
1	IN5+	9	IN5-
2	GND	10	GND
3	IN6+	11	IN6-
4	GND	12	GND
5	IN7+	13	IN7-
6	GND	14	GND
7	IN8+	15	IN8-
8	GND		

"ANALOG IN 9-12" connector

Pin	Signal	Pin	Signal
1	IN9+	9	IN9-
2	GND	10	GND
3	IN10+	11	IN10-
4	GND	12	GND
5	IN11+	13	IN11-
6	GND	14	GND
7	IN12+	15	IN12-
8	GND		

In order to make installation process easier, AEQ offers specific pre-fabricated cable kits for AEQ FORUM LITE audio input/output, both analog and digital, as well as studio headphones: FR CAB INP, consisting in a male DB15 connector soldered to 4 balanced and shielded 6 meters long paired cables with no connectors at the other end, for 4 inputs or outputs. For more information please check section 2.2.5 of this manual.

AEQ can upon request provide fully finished cables and in special lengths. For more information please refer to AEQ sales department or authorised distributors.

All 12 mono inputs can be configured, pair by pair, as 6 stereo inputs, depending on the particular application or installation, using the configuration software. For more information please check section "4.2.3. I/O Configuration submenu" of this manual.

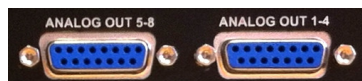

2.2.3.5. Analog outputs.

AEQ FORUM LITE includes 8 mono line-level outputs, electronically balanced, available through 2 female DB15 connectors identified as "**ANALOG OUT 1-4**" and "**ANALOG OUT 5-8**".

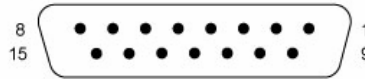

Analog Outputs (SUB-D female, 15 pins):

"ANALOG OUT 1-4" connector

Pin	Signal	Pin	Signal
1	OUT1+	9	OUT1-
2	GND	10	GND
3	OUT2+	11	OUT2-
4	GND	12	GND
5	OUT3+	13	OUT3-
6	GND	14	GND
7	OUT4+	15	OUT4-
8	GND		

"ANALOG OUT 5-8" connector

Pin	Signal	Pin	Signal
1	OUT5+	9	OUT5-
2	GND	10	GND
3	OUT6+	11	OUT6-
4	GND	12	GND
5	OUT7+	13	OUT7-
6	GND	14	GND
7	OUT8+	15	OUT8-
8	GND		

IMPORTANT NOTE: If you want to connect any of the outputs to an unbalanced input, you must unbalance the output, using the corresponding positive and GND pins and leaving the negative pin unconnected. Also keep in mind that unbalancing the output will reduce its level by 6dB.

In order to make installation process easier, AEQ offers specific pre-fabricated cable kits for AEQ FORUM LITE audio input/output, both analog and digital, as well as studio headphones: FR CAB INP, consisting in a male DB15 connector soldered to 4 balanced and shielded 6 meters long paired cables with no connectors at the other end, for 4 inputs or outputs. For more information please check section 2.2.5 of this manual.

AEQ can upon request provide fully finished cables and in special lengths. For more information please refer to AEQ sales department or authorised distributors.

All 8 mono outputs can be configured, pair by pair, as 4 stereo outputs, depending on the particular application or installation, using the configuration software. For more information please check section "4.2.3. I/O Configuration submenu" of this manual.



2.2.3.6. MIC/LINE inputs.

AEQ FORUM LITE includes 4 mono microphone/line inputs, available through 4 XLR female connectors identified as "**MIC/LIN-1**", "**MIC/LIN-2**", "**MIC/LIN-3**" and "**MIC/LIN-4**".

XLR - Female 3p. Balanced connection.

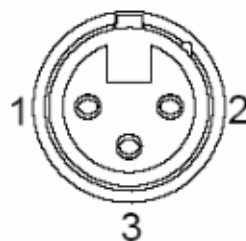

- Pin 1 → GND
- Pin 2 → Input +
- Pin 3 → Input -

All of them include independent, internally accessible programming jumpers to select operation as microphone or line input, and also activation/deactivation of the +48V **Phantom** power. By default, these inputs are configured for dynamic microphones without the need for Phantom power.

IMPORTANT NOTE: In the case of **MCORE**, there are no associated jumpers: it's possible to make this configuration as microphone/line or activate/deactivate the Phantom power from configuration software (see section 4.3.5.1 of this manual) or from the "CFG" menu in the main display of the control surface (see section 3.4.3.1.3.1 of this manual).

- **Programming inputs as line level or Phantom-powered Microphone inputs.**

Start by following the steps detailed at section 2.2.3.1 (it's **VERY IMPORTANT** to turn first the equipment off and disconnect the power supply cable). Then, at the 2 "MIC/LINE INPUTS AND PHANTOM POWER PROGRAMMING ZONES", you can activate individually the Phantom feed of each input or change from microphone level to line level as shown in the following images:

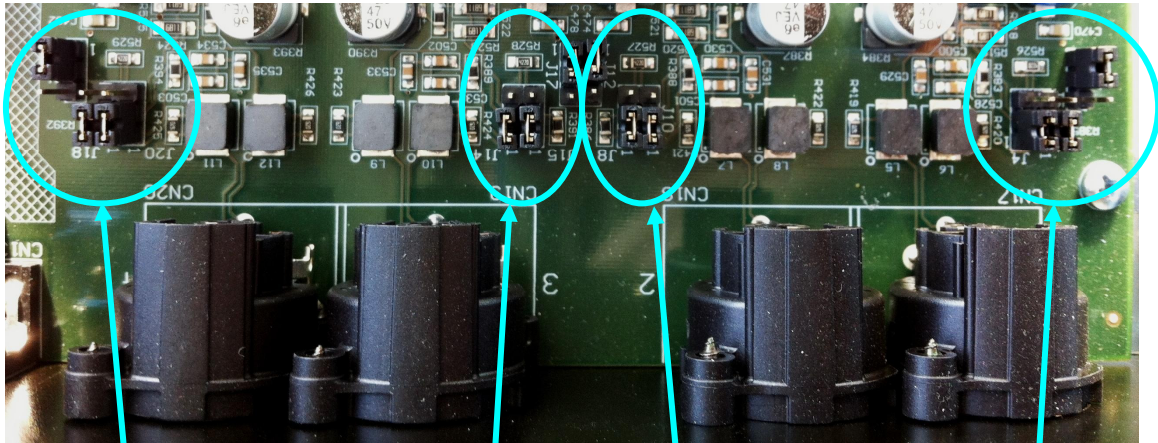

MIC/LINE input 4	MIC/LINE input 3	MIC/LINE input 2	MIC/LINE input 1
Jumpers J18 and J20	Jumpers J14 and J15	Jumpers J8 and J10	Jumpers J4 and J5
	Position 1-2: Microphone level		
	Position 2-3: Line level		
Jumper J22	Jumper J17	Jumper J12	Jumper J7
	Position 1-2: Phantom OFF		
	Position 2-3: Phantom ON		

MIC/LINE input 4	MIC/LINE input 3	MIC/LINE input 2	MIC/LINE input 1
Jumper J19	Jumper J13	Jumper J9	Jumper J3
	Position 1-2: Microphone level		
	Position 2-3: Line level		
Jumper J21	Jumper J16	Jumper J11	Jumper J6
	Position 1-2: Phantom OFF		
	Position 2-3: Phantom ON		

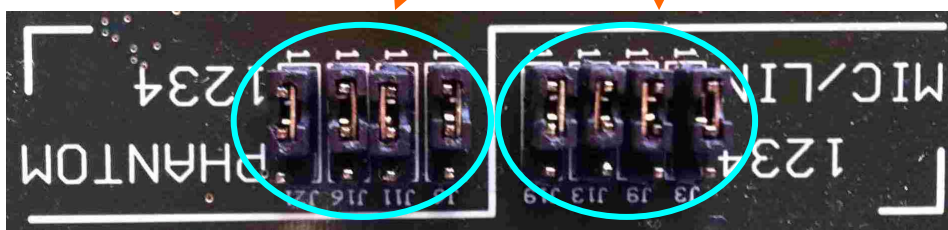

IMPORTANT NOTE 1: For each input, all jumpers associated with each option (mic/line or Phantom power) must be configured in the same position in both zones for a correct operation of the console. On the other hand, it's **VERY IMPORTANT** that the Phantom power activation is made (when needed) only in that/those input/s that are previously configured for microphone level.

The modification or activation of any of these options can be monitored from the internal menu available at the Control and Monitoring section in the AEQ FORUM LITE control surface main display. For more information please check section "**3.4.3.1.3 Enhanced information menu**" of this manual.

IMPORTANT NOTE 2: Regarding the wiring, the chassis of microphones must be connected to the chassis of the console frame in order to protect the microphone inputs against uncontrolled static shocks. Pin 1 (Ground) must be connected to the metal case of XLR connector in the available terminal for this purpose, so any static shock will be downloaded to ground through the frame chassis. This rule must be followed in every connector throughout the cable in case of connections by means of aerial connectors. In the same way, for AES3 or USB digital signals, the chassis of PCs or other digital audio devices must be also connected to the chassis of the console frame.



2.2.3.7. USB inputs and outputs.

AEQ FORUM LITE includes 2 stereo USB digital inputs/outputs available through 2 type-B USB connectors identified as "**USB 1**" and "**USB 2**". Each one includes 1 input and 1 output.

When you connect a USB module to a PC through any of the USB ports, the PC will automatically recognize it as a new audio device (it will be shown as "USB Audio CODEC"). To this device you can send audio from any audio playback application in the same way as if it was an external professional audio board. It is also possible to record any audio from the mixing console in the computer by using any recording application.

These boards are "plug&play" on Microsoft Windows™ and Apple Computer Mac OS™ operative systems, no specific driver is needed. When you connect several USB ports from one or several USB modules to the same PC, the operative system will show a new audio device for each one, that will be identified as "USB Audio CODEC", "USB Audio CODEC (2)"...

Supported sampling frequencies are 32 KHz, 44.1 KHz and 48 KHz, with sampling rate converters (SRC) to 48 KHz that corresponds to the internal sampling rate of the system.

IMPORTANT NOTE 1: It's necessary to use shielded cable in order to establish connection between USB module and PC.

IMPORTANT NOTE 2: Regarding the wiring, the chassis of microphones must be connected to the chassis of the console frame in order to protect the microphone inputs against uncontrolled static shocks. Pin 1 (Ground) must be connected to the metal case of XLR connector in the available terminal for this purpose, so any static shock will be downloaded to ground through the frame chassis. This rule must be followed in every connector throughout the cable in case of connections by means of aerial connectors. In the same way, for AES3 or USB digital signals, the chassis of PCs or other digital audio devices must be also connected to the chassis of the console frame.

2.2.3.8. AoIP inputs and outputs.

The integrated multichannel AoIP interface can be found at the back panel of AEQ FORUM LITE, labelled as "Dante". This module provides up to 16 (or 32, depending on hardware) mono input and output audio channels.

The module has 2 Ethernet connectors identified as "AoIP LAN 1" (main interface) and "AoIP LAN 2" (secondary interface), both with its corresponding signalling LEDs. Those LEDs indicate the status of audio local network connection:

- Off: no local network connection.
- Blinking green: link established at data level.
- Fixed yellow: link established at physical level.

When module is connected to a single DANTE audio network through switch, the green LED must be blinking and the yellow one must remain fixed only in LAN 1 connector. When module is connected in "Daisy Chain" mode, without switch, or there is a redundant network, both green LEDs must be blinking and both yellow ones must remain fixed.

NOTE: AoIP (audio over IP) functionality is not compatible with **MADI** functionality, both options can't be active at the same time.

2.2.4. Optional inputs/outputs modules.



2.2.4.1. MADI multichannel optional module.

The integrated multichannel MADI interface physical connector can be found at the back panel of AEQ FORUM LITE, labelled as "MADI". This interface is not equipped by default unless option "**CA11: MADI MODULE**" has been purchased.

If you acquire this option later on, simple instructions will be enclosed with the module, allowing easy installation by any person with minimal experience in handling electronic equipment or computers.

MADI protocol, which stands for multichannel audio digital interface is a professional standard of data transmission for digital audio signals over 56 channels on a single cable. MADI protocol is documented in the standard AES10-1991 and ANSI s4.43-1991.

AES10 MADI multichannel interface is an extension of AES3 protocol for interconnection of multi-channel. MADI protocol, as defined in the AES10 standard allows connection of up to 64 audio channels (linearly quantified data) with a resolution of 24 bits per sample and a sampling rate frequency of 48 kHz/s. Transmission is accomplished in a serial mode and if transmission is done on a single 75 ohm coaxial cable with BNC connectors the distance reached is greater than 50 m. If transmission is accomplished on a multi-mode fiber-optic interface (transceiver) with the specifications that the AEQ FORUM LITE is providing the distance is up to 2 km.

The audio samples may have a maximum of 32 bit quantization. Additionally, by using this protocol, the bits of validity user status and parity of AES3 are maintained. The MADI protocol allows you to connect 64 audio channels with a single pair of wires. The data bit rate is 100 MBits/s corresponds to a synchronous connection.

AEQ FORUM LITE MADI Interface Specifications:

- Optical fiber connector, FDDI PMD type.
- Nominal range: 2000 meters.
- Fiber Type: 62.5 / 125 μ m MULTIMODE
- Transmission: LED, 1300 nm

NOTE 1: in order to activate this function you must purchase a user license.

NOTE 2: **MADI** functionality is not compatible with **AoIP** (audio over IP) functionality, both options can't be active at the same time.



2.2.4.2. Telephone hybrid optional module.

At the back panel of AEQ FORUM LITE, integrated double digital telephone hybrid module connectors can be found, labelled as "**HYBRID-1**" and "**HYBRID-2**". This interface is not equipped by default unless option "**CA33: DOUBLE DIGITAL TELEPHONE HYBRID MODULE**" has been purchased.

If you acquire this option later on, simple instructions will be enclosed with the module, allowing easy installation by any person with minimal experience in handling of electronic equipment or computers.

Hybrid module has enough capacity to handle two independent phone lines. It has two RJ11 connectors, labelled "**LINE**" to connect the physical phone lines, and two more, labelled as "**SET**" for loop connections to both external telephone terminals where dialing actions will be performed.

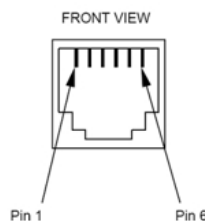

RJ11 connector

Control and configuration of the signals present in this module are performed using the configuration software. For more information, please refer to section "4.2. Hardware Configuration menu" of this manual.

If this option is not purchased and external compatible communication devices are used, you can control them using the programmable key section of AEQ FORUM LITE control surface. For more information, please refer to section "4.3.2.4. Configuration of Codec programmable keys" of this manual.

2.2.5. Wiring.

All wiring kits described below are optional and have been designed by AEQ to simplify the installation of the unit. To facilitate the quick connection of the console in almost any installation, AEQ can supply audio and data cables with the corresponding DB-type connectors that are used to connect the unit. These cables can be cut to desired lengths and soldered on patch panels, punched into connector strips or fitted with the corresponding connectors to be used directly connected to the peripheral equipment.

For easiest installation, FORUM LITE console uses a single type of Multiconnector: **female DB 15**, so only two types of cable are required: data and audio. Their description (for the maximal configuration) is:

- **FR CAB INP:** Male DB15 connector connected to a balanced and shielded four pair, 6-meter cable with open-end termination, for 4 audio inputs or outputs. Max 9 cables per console.

- **CP CAB GPIO:** Male DB15 connector, soldered to 6-meter long multiwire (interphone type), not terminated, for GPI, GPO or relays for FORUM LITE console. Max 3 cables per console.

AEQ can upon request provide fully finished cables and in special lengths. For more information please refer to AEQ sales department or authorised distributors.

- **FR CAB INP pinout and use.**

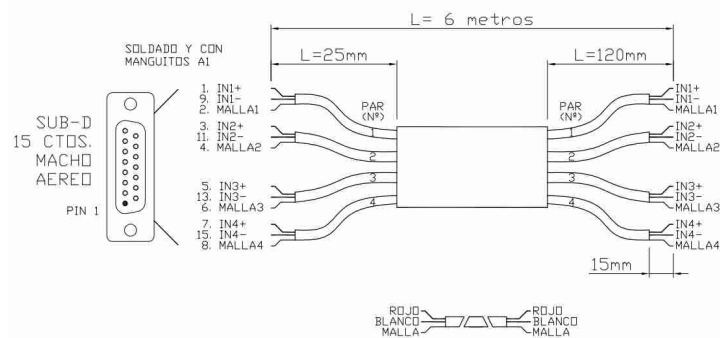

- **CP CAB GPIO pinout and use.**

Wire	Color table Color	GPI		GPO		GPO (RELAY)	
		Signal	PIN	Signal	PIN	Signal	PIN
1	Red	GPI1	1	GPO1	1	GPO RL1NO	1
2	White	GPI2	2	GPO2	2	GPO RL1NC	2
3	Green	GPI3	3	GPO3	3	GPO RL2NO	3
4	Yellow	GPI4	4	GPO4	4	GPO RL2NC	4
5	Blue	GPI5	5	GPO5	5	GPO RL3NO	5
6	Grey	GPI6	6	GPO6	6	GPO RL3NC	6
7	Black	GPI7	7	GPO7	7	GPO RL4NO	7
8	Brown	GPI8	8	GPO8	8	GPO RL4NC	8
9	Orange	GND-GPI 1-4	9	GND-GPO 1-4	9	GPO RL1COM	9
10	Purple	GND-GPI 1-4	10	GND-GPO 1-4	10	Not connected	10
11	White / Red - Grey / Red	GND-GPI 1-4	11	GND-GPO 1-4	11	GPO RL2COM	11
12	White / Blue	Not connected	12	Not connected	12	Not connected	12
13	Yellow / Red	GND-GPI 5-8	13	GND-GPO 5-8	13	GPO RL3COM	13
14	Blue / Red	GND-GPI 5-8	14	GND-GPO 5-8	14	Not connected	14
15	Orange / Red - White / Black	GND-GPI 5-8	15	GND-GPO 5-8	15	GPO RL4COM	15
Chassis	White / Green						

Each individual wire color can vary between manufacturing batches. Please use the color code that is supplied with the cable bundle.

IMPORTANT NOTE: Regarding the wiring, the chassis of microphones must be connected to the chassis of the console frame in order to protect the microphone inputs against uncontrolled static shocks. Pin 1 (Ground) must be connected to the metal case of XLR connector in the available terminal for this purpose, so any static shock will be downloaded to ground through the frame chassis. This rule must be followed in every connector throughout the cable in case of connections by means of aerial connectors. In the same way, for AES3 or USB digital signals, the chassis of PCs or other digital audio devices must be also connected to the chassis of the console frame.

3. DESCRIPTION OF THE INTERNAL MENU.

The AEQ FORUM LITE internal menu is displayed on the main display of the Control and Monitoring section of the control surface.

Most of them allow you to modify the values shown (although some pages of the internal menu are merely informative), changing routing, gains or applying processes to the audio signals. For this purpose, the three rotary encoders and the four contextual keys associated with this display will be used.

Depending on the information shown on the last line of the menu display, the four contextual keys immediately beneath the display will have different functions. This last line of the menu will have a maximum of four visible options.

The three rotary encoders are associated with the options shown in the menu (each specific menu will be explained in detail later in this manual). The specific association of the encoders is following the next thumb rule: the menu option that is shown farthest to the left or in the highest position is controlled from the encoder located farthest to the left.

The default screen of AEQ FORUM LITE shown in the main Control and Monitoring section display includes the AEQ logo, the product name AEQ FORUM LITE, the active user and current date and time.



The four options visible on the last line of the display are associated with the four contextual keys below, from left to right:

- **"CLOCK"**: allows you to access to the system date and time configuration menu, as well as to the chronometer and countdown functions.
- **"LOGOU"/"LOGIN"**: allows you to access to the users registration menu ("LOGIN") or leave the current active user ("LOGOU").
- **"MEMORY"**: allows you to access to the system snapshot memory bank. There are 10 memory positions available in order to store different configurations.
- **"MENU"**: allows you to access to the advanced menu for audio inputs/outputs, routing and processing configuration.

In the upper right part of the display the active user at that moment is shown. For more information, please refer to section **"3.2. LOGIN/LOGOUT menu"** of this manual.

3.1. "CLOCK" menu.

This menu enables you to set the date and time displayed in the system (but not the option of synchronization with an external master clock, which is only configurable from the configuration software: see section 4.2.6 in this manual), as well as activate and control the Chronometer and Countdown functions.

The initial screen shows the current system time (HH/MM/SS) and, up on the right, the date (DD/MM/YY).



The four options visible on the last line of the display are associated with the four contextual keys below, from left to right:

- **"BACK"**: returns to the previous menu screen.
- **"SET"**: enables you to access to the date and time configuration menu. When you access to this menu, the **time configuration** is available (a flashing arrow is displayed next to the current time) by means of using the 3 rotary encoders (turning the first one allows you to change the hour, the second one the minutes and the third one the seconds).

When you press the **"DATE"** contextual key, you access to the **date configuration** menu (the flashing arrow changes its position and the **"DATE"** changes to **"TIME"**): by pressing the first encoder you can change between day of the week and day of the month and by turning it allows you to change the selected option; you can configure the month by turning the second encoder and the year by turning the third one.

Once date and time are configured, you can press the **"SET"** key in order to save the changes and return to the previous screen or the **"BACK"** key in order to return to that screen without changes saving.

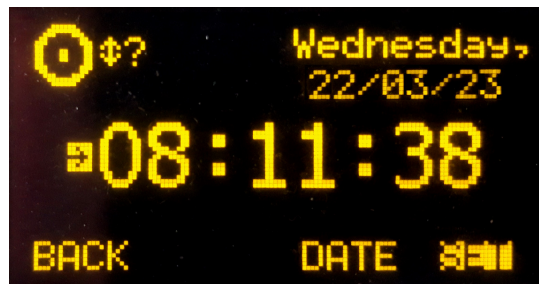

- **"CDOWN"**: lets you configure and activate the AEQ FORUM LITE Countdown option through the associated rotary encoders. The format on screen is HOURS:MINUTES:SECONDS.

You can configure the hours by turning the first encoder, the minutes by turning the second one and the seconds by turning the third one. The **"START"** contextual key launches the countdown, the **"STOP"** key (the same key that changes its function) brings it to a stop, and the **"RESET"** key re-establishes the initially configured value (even when the countdown is launched). The **"BACK"** key allows you to return to the previous screen (it also stops the countdown and re-establishes the initial value).

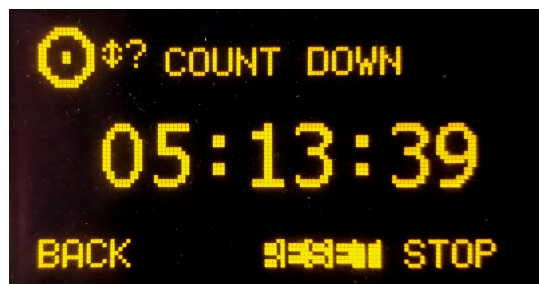

- **"CHRONO"**: enables you to configure and activate the chronometer option. The format on screen is HOURS:MINUTES:SECONDS.
The **"START"** contextual key initiates the chronometer, the **"STOP"** key (the same key that changes its function) stops it, and the **"RESET"** key re-establishes the initial zero value (even when the chronometer is launched). The **"BACK"** key allows you to return to the previous screen (it also stops the chronometer and re-establishes the initial zero value).

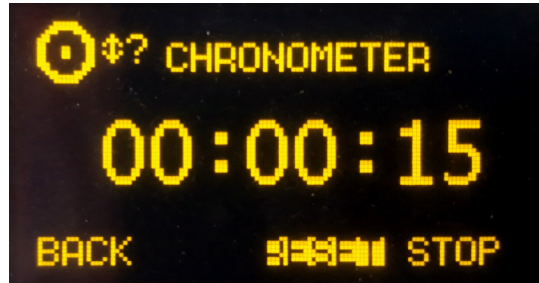

3.2. "LOGIN/LOGOUT" menu.

This menu allows AEQ FORUM LITE users/operators to register in the system, so that the equipment recognizes their user level by the associated password, and assigns them an access level for subsequent operation in the different console submenus.

AEQ FORUM LITE allows up to 17 different user levels.

There are 4 user levels defined by default in the console: "ADMINISTRATOR", "ADVANCED", "BASIC" and "NOT LOGGED". The "ADMINISTRATOR" level has all the available permissions. The "NOT LOGGED" level corresponds to a generic user with no associated password, which is accessed by pressing the **"LOGOU"** contextual key in the console's initial menu (that key changes to **"LOGIN"**).

The permissions associated with each user level can be checked in the "User Levels" submenu of the "Forum Lite Setup" application. Section 4.1.2 of this manual details this submenu, as well as the process for creating and modifying the system user levels.

The system available users (and the password and user level associated with each of them) can be checked in the "User Configuration" submenu of the "Forum Lite Setup" application. Section 4.1.3 of this manual details this submenu, as well as the process for creating and modifying the system users.

The **"LOGIN"/"LOGOU"** contextual key has two possible uses: LOGIN to register yourself (depending on the password used you will access to a certain level) and LOGOUT to de-register (this way you gain access to "NOT LOGGED" user level). When you register through the option **"LOGIN"**, the "PASSWORD" screen appears: six spaces are displayed on screen associated with the six digits (as maximum) of the password. The password must be configured previously from the configuration software (see section **"4. CONFIGURATION SOFTWARE"** of this manual). The password supplied by default for **"Admin"** user ("ADMINISTRATOR" user level) is **1234**.

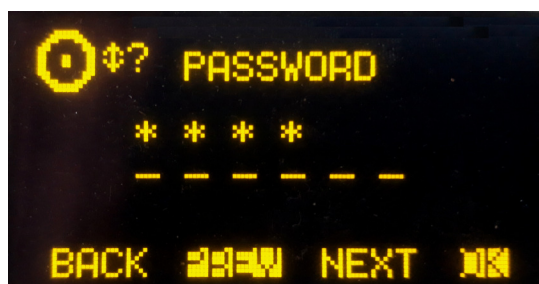

The procedure for entering the password requires the use of the contextual keys beneath the display and any of the three associated encoders.

By **turning** any of the 3 encoders you can select the desired digit; by **pressing** any of the 3 encoders you can confirm your selection as part of the password and change to the following position (when you press an encoder after selecting the sixth digit, it's equivalent to press the "OK" key).

The four contextual keys are associated with the four options displayed in the bottom line of the display:

- **"BACK"**: pressing this key allows you to return to the previous menu screen.
- **"PREV"**: enables you to move to the left through the six positions that make up the password.
- **"NEXT"**: enables you to move to the right through the six positions that make up the password.
- **"OK"**: allows you to confirm that all the digits of the password have been entered and, if password is correct, change to the associated user (the main display shows then the initial AEQ FORUM LITE screen with the user up on the right and the second contextual key identified as "LOGOU"). When you enter an incorrect combination of digits, a **"WRONG PASSWORD"** message is displayed (the "BACK" key allows you to return to the previous screen in order to insert the password once again).

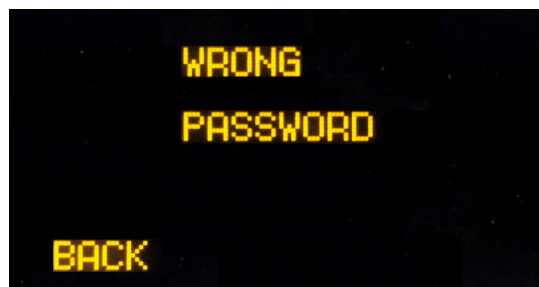

3.3. "MEMORY" menu.

This menu enables you to manage the system configuration memories or snapshots. In two consecutive screens, up to 10 memory positions are shown, which are the ones available for storing configurations. For each system user, only the snapshots assigned to that user (or to all users) and the first snapshot (always available) are shown: see section 4.3.5 of this manual.

Each one of these memory positions stores all of the parameters in use at that time in each one of the console channel: gain, phase and balance configuration, "PROGRAM", "AUDITION", and/or "CUE" routing activation, configuration/activation of equalizers, filters and/or dynamics processes and channels activation/deactivation (ON/OFF). No fader position is stored, because these are set manually. The memory position also stores the activation of signals sending to control and studio monitoring (by means of the keys placed under the corresponding displays), but not the position of the 3 associated encoders.

The first of these screens displays the first 4 memory positions, the second shows the following 4 memory positions and the third one the last 2 memory positions. You can shift between these screens by turning any of the associated encoders as you move through the complete list of snapshots stored at that time. The memory that is selected at any time is highlighted.

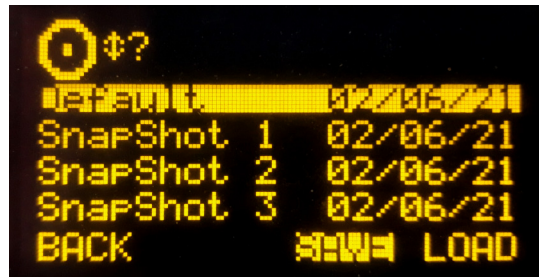

Each stored memory is identified by its name and the date on which it was created. The names of the memories are editable from the configuration software (see section 4.3.5 in this manual).

The options available through the contextual keys below the screen, from left to right, are:

- **"BACK"**: pressing this key allows you to return to the previous menu screen. No change you may have made is saved.
- **"SAVE"**: stores in the selected memory position the configuration of the console at that moment. The system will ask for your confirmation (in the screen that appears, you can confirm by pressing "SAVE" again or return to the memories list by pressing "BACK").
- **"LOAD"**: allows you to load the configuration you stored previously in the selected memory position. The system will ask for your confirmation (in the screen that appears, you can confirm by pressing "LOAD" or return to the memories list by pressing "BACK").

IMPORTANT NOTE: When a new configuration memory or snapshot is loaded, the audio of the activated channel or channels (ON AIR) will not be interrupted (and the associated routing will remain) provided that in the new memory the activated channels are placed in the same fader positions. The routing toward MPX internal summing buses of any signal will also remain (whether the signal is ON AIR or not).

You can also create snapshots with different configurations from the configuration software. See section 4.3.5 of this manual.

3.4. "MAIN MENU".

Pressing the "MENU" key in the initial screen will take you to the "MAIN MENU" screen. From this advanced configuration menu you can control, among other parameters, audio inputs/outputs, internal routing and processes. The four options visible on the last line of the display are associated with the four contextual keys below, from left to right:

- **"BACK"**: pressing this key allows you to return to the previous menu screen.
- **"INFO"**: essentially a maintenance menu displaying information about the IP address of the "LAN" network port present in the rear panel of the unit and firmware versions installed in the several console operating modules, as well as the routing and process DSPs percentage of use.
- **"SETUP"**: which displays and allows you to change the IP configuration associated with the Ethernet port available on the rear panel of the equipment ("LAN": see section 2.2.2.2 of this manual) in the form of IP address, subnet mask (MASK) and gateway (GWAY). Only level 3 users can modify these parameters (the "SETUP" key is shown to other users but is not active).
- **"SELECT"**: advanced configuration of audio inputs/outputs, internal routing and processes.



3.4.1. "INFO" menu.

This is a menu specifically for technical maintenance. The "INFO" menu lets you display the IP configuration associated with the Ethernet port available on the rear panel of the equipment ("LAN": IP address, subnet mask and gateway are shown), the firmware versions installed in the several console operating modules and the routing and process DSPs percentage of use.

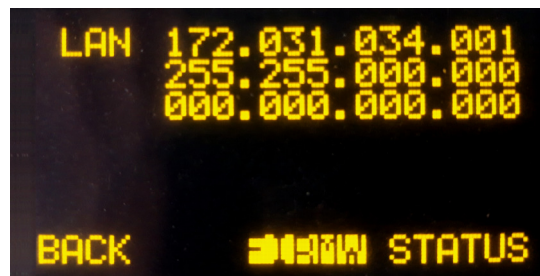

The three options visible on the last line of the display are associated with three of the four contextual keys below, from left to right:

- **"BACK"**: pressing this key allows you to return to the previous menu screen.
- **"FIRMW"**: in successive screens, which are accessed by turning any of the associated encoders, you can display the firmware versions installed in the different modules that make up the console: the 4 modules that make up the main board of the console (CPU, FPGA, Routing DSP and Process DPS) are shown as "MAIN BOARD" and the MSC module (control and monitoring section) and the FSC modules (4 faders modules) are shown as "CONTROL SURFACES".

Each line is identified by the specific module and its reference, as well as the version and the date of the currently installed specific firmware.

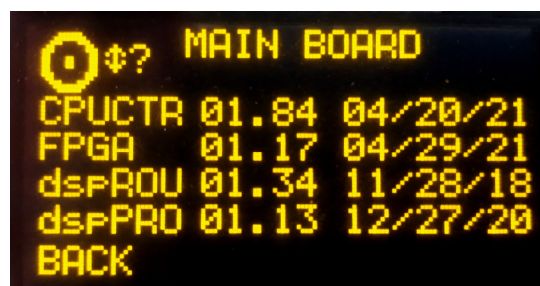

- **"STATUS"**: allows you to access to the information regarding the routing and process DSPs percentage of use. In case the working limit of any of them is exceeded the indication "OVL" (Overload) is shown.

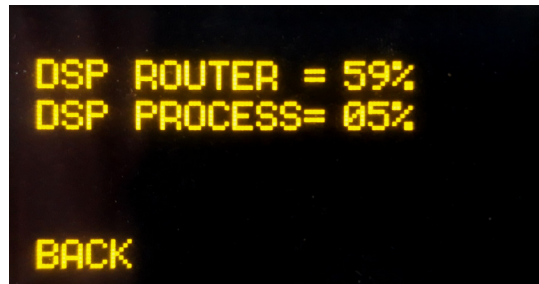

3.4.2. "SETUP" menu.

Through the "IPSET" option in a contextual key, this menu enables you to display and modify the IP configuration associated with the Ethernet port available on the back panel of the equipment ("LAN" see section 2.2.2.2 of this manual) in the form of IP address, subnet mask (MASK) and gateway (GWAY). Only level 3 users are allowed to modify these parameters (the "SETUP" key is shown to other users but is not active).

As in many other AEQ FORUM LITE console submenus, the icon in the upper left-hand corner indicates that browsing and configuration are performed by using the associated rotary encoders.

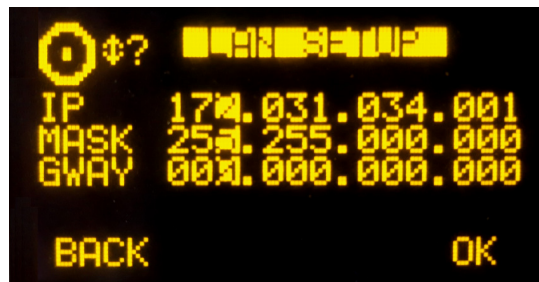

From left to right, the three rotary encoders are associated with "IP", "MASK" and "GWAY" fields respectively. Each one of these fields consist of 4 number separated by dots and named bytes.

A flashing cursor indicates the byte that is subject to be changed at that moment by turning the associated encoder. Pressing any of the 3 encoders allows you to change from one byte to the next one. This process is repeated from left to right until the IP address is complete, as well as the associated subnet mask and gateway.

The "OK" contextual key allows you to validate and save the changes, returning then to the previous screen. The "BACK" contextual key allows you to return to the previous screen without changes saving.

3.4.3. "SELECT" menu.

This menu enables you to perform advanced configuration operations on audio inputs/outputs, processes and internal routing of all of the signals present in the console.

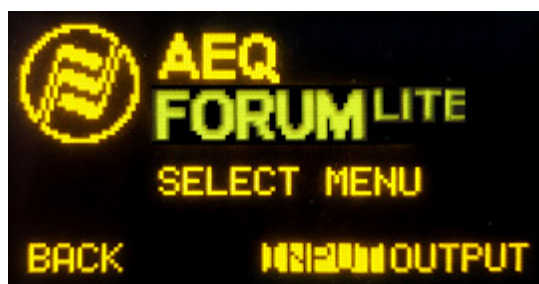

The options available through the contextual keys below the screen, from left to right, are:

- **"BACK"**: pressing this key allows you to return to the previous menu screen.
- **"INPUT"**: configuration of input audio signals, as well as processes and routing associated with those signals.
- **"OUTPUT"**: configuration of output audio signals, as well as associated routing and tones activation.

3.4.3.1. "INPUT" menu.

This menu shows a list of all the audio input logical signals defined in the system from the configuration software. For more information, see section **"4. CONFIGURATION SOFTWARE"** in this manual.

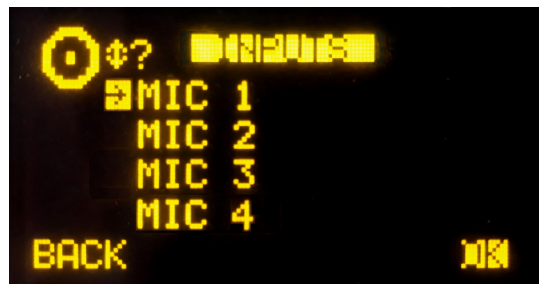

You can access a more complete description of each one of the input audio channels by turning any of the 3 associated encoders and pressing then the "OK" contextual key or any of these encoders. The information showed on this screen, from top to bottom and left to right, is:

- **Name of the channel**, in alphanumeric format containing up to 6 characters. This is the same identifier as the one shown in the channel display. See section **"2.1.1.3. Channel display"** in this manual.



- **Hardware** corresponding to the audio input of this channel, in format HW: xx.yy, where xx is the number of the virtual slot where this inputs/outputs module is installed, and yy is the audio channel of this inputs/outputs module. In stereo channels, yy represents the audio channel corresponding to the left channel of the stereo pair. The right channel corresponds to the number just above.
- Graphic representation of three **encoders** associated with the **GAIN**, **PHASE** and **BALANCE** fields. By operating on the rotary encoders associated with the main screen in the Control and Monitoring section, you can change the values.
 - **GAIN**: configurable between -12dB and +12dB for line level inputs and between -36dB and +19dB for mic level inputs. The field is configured with the default value of 0dB. Any modification of the initial value of this gain will illuminate the dedicated **"PROCESS" LED** on the corresponding channel of the control surface (see section **"2.1.1.5. Indicator of active processes"** of this manual).
 - **PHASE**: allows you to modify the input signal phase among +/+, +/-, -/+ and -/- for stereo signals, and among + and - for mono signals.

- **BALANCE:** enables you to modify the balance between the L and R channels in stereo signals. The operation of this indicator will activate the dedicated **"PROCESS" LED** on the corresponding channel of the control surface (see section **"2.1.1.5. Indicator of active processes"** of this manual).
By pressing this encoder, you can configure the sending mode of the stereo input signal toward the stereo outputs that it is routed to. The options that appear successively when you press the encoder are: **L-L** (only the L input channel is sent to L and R output channels), **R-R** (only the R input channel is sent to L and R output channels) and **R-L** (the R input channel is sent to the L output channel and the L input channel is sent to the R output channel). If you press the encoder once more, it returns to the normal working mode (**L-R**).

NOTE: When the input audio channel selected in the "INPUTS" list is assigned to a fader channel, you can also access to this advanced information screen by pressing the **"SELECT"** key of the corresponding channel (see section **"2.1.1.2. SELECT"** of this manual), working this key as a quick access to this submenu. Using any of both access ways, the LED of the "SELECT" will be activated.

The four contextual keys under the display are associated with the four options shown in the bottom line of the screen:

- **"BACK":** pressing this key allows you to return to the previous menu screen.
- **"DYNAM":** allows you to access to the menus for configuration and activation of dynamics effects included in AEQ FORUM LITE: Compressor/Limiter and Noise Gate.
- **"EQUAL":** allows you to access to the menu for configuration and activation of Equalizers and Filters included in AEQ FORUM LITE.
- **"NEXT":** allows you to access the additional information menu about the audio signal present in this input channel, where you can also change the signal assigned to that channel and modify its internal routing. In mic/line channels it's also possible to configure them as mic or line and to activate/deactivate the Phantom power.

3.4.3.1.1. Dynamics menu: Compressor/Limiter and Noise Gate.

COMPRESSOR / LIMITER:

Pressing the **"DYNAM"** contextual key from the advanced information menu of an audio input channel will give you access to the menu to configure the Compressor/Limiter.

Dynamics processors are used to modify the dynamic ranges of an audio signal to adapt it to specific needs or to produce certain sound effects. A compressor enables you to reduce the dynamic range of the signal. Your purpose may be to adapt a signal with a very broad dynamic range to a circuit that will not support such wide variations in level, or to generate certain sonority in a signal.

The **"Compressor / Limiter"** function acts as a "constant gain" compressor; that is, below the threshold, all input signals are amplified (or not amplified) equally, while above the threshold, the input levels are reduced to a greater or lesser degree according to the compression ratio.

If the compression range selected is the maximum, the function will act as a limiter in such a way that the signals that exceed the selected threshold at input will not exceed a certain level at output. For example, with a threshold = 0 dB, a gain of 10 dB and a compression ratio of 1:50, you will ensure that all the signals that exceed 10 dB at input will also be output at 10 dB, while the signals that are below the threshold will have an overall gain of 10 dB.



From top to bottom and left to right, the information displayed on the Compressor/Limiter configuration and control screen comprehends:

- **"THR" (Threshold):** this is the threshold above which the compressor will act. Signal levels that exceed this threshold will be affected by the compressor settings. The threshold range varies from -42dB to +22dB.
- **"ATT" (Attack Time):** this is the time it takes the compressor to react to an increase in the input signal. The shorter this time, the more sensitive the compressor will be to pulse signals, and the higher the action on this type of signals. With a long attack time, the compressor will not respond so well to pulse changes in the input signal. It ranges between 0.5 and 95 ms.
- **"REL" (Release Time):** this is the maintenance time during which the compressor keeps acting, even when the level of the input signal has fallen below the threshold. A long release time will maintain uniform compression, even when there are quick level fluctuations in the signal. A short time will enable the compressor to adapt more quickly to pulse fluctuations in the signal. It ranges between 10 and 9500 ms.
- **"RAT" (Compression Ratio):** this is the compression ratio. A ratio of 1:1 does not involve any variation in the signal, as the level of the input signal is maintained at the output. A ratio of 2:1 indicates that the level of an input signal which exceeds the threshold will be reduced to half at the output. The highest ratio available is 50:1, which will be used to implement signal limiters. The limiter must reduce all signals exceeding a certain level to that level.
- **"G" (Gain):** this enables you to apply a general gain to the signal. This entails a general increase of the signal level, which will be especially noted at low input levels that are under the threshold set. A general increase in the level of the signal may generate saturation at the output, even when the signal is being limited. It ranges between 0 and +40dB.

A cursor blinks over the fields placed on the left or on the right to indicate the fields that can be modified at that moment. To change from the one to another just press any of the three associated encoders. When you select the fields on the left, turning the first encoder allows you to change "THR", the second one changes "ATT" and the third one changes "REL"; when you select the fields on the right, turning the first encoder allows you to change "RAT" and the second one changes "G" (the third one has no function in this case).

NOTE: To correctly set a limiter, a threshold between 0 and +22dB should be selected, with a compression ratio of 50:1 and a gain of 0dB.

The **"COMP"** contextual key enables you to activate the compressor whose parameters are shown at that time on the screen. The activation of the compressor is confirmed by the activation of the **LED** of the contextual key and the **LED "PROCESS"** of the selected mixer channel (see section **"2.1.1.5. Indicator of active processes"** of this manual). The **"COMP"** contextual key also enables you to return to the Compressor/Limiter menu when you are in the Noise Gate menu (in that case, the associated LED lights for a moment and then it turns off).

IMPORTANT NOTE: The dynamics process, and especially the Compressor/Limiter, requires either extensive experience or caution and time to check, while off the air, the result obtained on the signal. Without these precautions, you may generate sound effects that can be perceived as dirty sound, lack of definition, distortion and other defects in general.

By pressing the **"NGATE"** contextual key you will access the screen dedicated to the control and configuration of the Noise Gate for that input channel (the associated LED lights for a moment and then it turns off).

NOISE GATE:

A noise gate is a dynamics processor that lets signals through whose level exceeds a certain threshold, strongly attenuating the signal levels below that threshold and thus muting noise. It enables its user to eliminate extraneous noise from a signal source, whether it is background noise in the studio, in the case of a microphone, or the background noise generated by a playback device, for example, a tape.

From top to bottom and left to right, the information shown in the Noise Gate configuration and control screen is as follows:

- **"ATT"**: Attack Time. It ranges between 0 and 95 ms.
- **"REL"**: Release Time. It ranges between 0 and 9000 ms.
- **"HOL"**: Hold Time. It ranges between 0 and 2000 ms.
- **"THR"**: Threshold. It ranges between -72 and 0dB.
- **"R"**: Range. It ranges between 0 and 90dB.

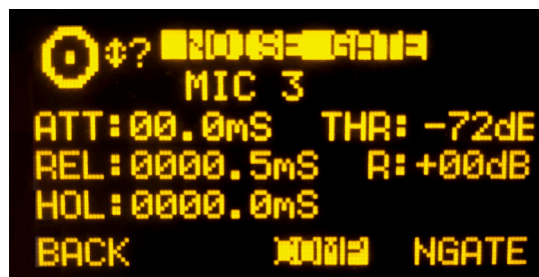

A cursor blinks over the fields placed on the left or on the right to indicate the fields that can be modified at that moment. To change from the one to another just press any of the three associated encoders. When you select the fields on the left, turning the first encoder allows you to change "ATT", the second one changes "REL" and the third one changes "HOL"; when you select the fields on the right, turning the first encoder allows you to change "THR" and the second one changes "R" (the third one has no function in this case).

When establishing the settings, the threshold for the noise gate will be much lower than in the case of the compressor, as its operation is the opposite. The noise gate prevents the passing of lower levels of the signal that could be considered noise. Therefore, the range of settings is different. In addition, there is an additional parameter for noise gates, which is "Hold Time." This is a safety period used to prevent the gate from accidentally closing if a signal is suddenly absent, for example, in speech.

In addition, the threshold must be adjusted to a level slightly higher than the level of the noise to be avoided. Thus, the threshold will be set at a very low level. Above the threshold, the noise gate does not act (unity gain), letting the rest of the signal through without processing it. The gate remains closed; i.e. when the signal surpasses the threshold level, the gate opens. The attack time is the time the gate takes to open (unity gain) when it receives a signal whose amplitude exceeds the threshold level; this time must be short to avoid cutting off the beginning of a sentence or song. The release time is the time the gate takes to close when the signal level falls below the threshold. The hold time is the minimum time during which the gate remains open; it is used to prevent the gate from closing when the signal level drops briefly—for example, when an announcer pauses while speaking. The hold time prevents the gate from opening and closing constantly in the presence of a signal whose level fluctuates in a range close to the threshold level.

The **"NGATE"** contextual key enables you to activate the noise gate whose parameters are shown at that time on the screen. The activation of the noise gate is confirmed by the activation of the **LED** of the contextual key and the **LED "PROCESS"** of the selected mixer channel (see section **"2.1.1.5. Indicator of active processes"** of this manual). The **"NGATE"** contextual key also enables you to return to the Noise Gate menu when you are in the Compressor/Limiter menu (in that case, the associated LED lights for a moment and then it turns off).

3.4.3.1.2. Equalizer and filter menu.

Pressing the **"EQUAL"** contextual key from the advanced information menu of an audio input channel will give you access to the menu to configure the equalizer and filters.

The upper part of the screen shows the channel identifier name and the middle area of the screen shows the graphic representation of the response curve of the equalizer and filters that are active at that time.



The four options visible on the last line of the display are associated with the four contextual keys below, from left to right:

- **"BACK"**: pressing this key allows you to return to the previous menu screen.
- **"HPF"**: allows you to activate the configured high pass filter (the associated LED will light). Pressing this contextual key for three seconds opens the cut-off frequency configuration menu: this configuration is accomplished by turning the first associated encoder and pressing the **"BACK"** contextual key to return to the previous screen once this parameter is configured (between 20 and 1000Hz).



- **"LPF"**: allows you to activate the configured low pass filter (the associated LED will light). Pressing this contextual key for three seconds opens the cut-off frequency configuration menu: this configuration is accomplished by turning the first associated encoder and pressing the **"BACK"** contextual key to return to the previous screen once this parameter is configured (between 1000 and 20000Hz).



- **"EQ"**: allows you to activate the equalizer whose frequency response is shown at that time on the screen (the associated LED will light). This frequency response is controlled from the associated encoders by working from left to right on the base, mid-range and treble bands, respectively. The frequency deviation permitted ranges from -18dB to +18dB (the default value is +0dB).

Pressing this contextual key for three seconds opens the equalizer advanced configuration menu, where 3 rows appears for base ("LOW"), mid-range ("MID") and treble ("HIG") bands respectively. You can change from one band to another by pressing any of the three associated encoders. In the selected band (a flashing arrow is displayed), you can change the **central frequency** ("F(Hz)" column) by turning the first encoder, the **Q** ("Q" column) by turning the second encoder and the **gain** ("G(dB)" column) by turning the third encoder. The "HPF", "LPF" and "EQ" contextual keys in this screen allows you to activate filters and equalizer; the "BACK" key allows you to return to the graphic configuration screen.

3.4.3.1.3. Expanded information menu.

Pressing the **"NEXT"** contextual key from the advanced information menu of an audio input channel will give you access to the advanced information section of that channel. It maintains a structure similar to the base menu. Information shown on this screen:



- **Name of the channel**, in alphanumeric format containing up to 6 characters. This is the same identifier as the one shown in the channel display. See section **"2.1.1.3. Channel display"** in this manual.
- **Hardware** corresponding to the audio input of this channel, in format HW: xx.yy, where xx is the number of the virtual slot where this inputs/outputs module is installed, and yy is the audio channel of this inputs/outputs module. In stereo channels, yy represents the audio channel corresponding to the left channel of the stereo pair. The right channel corresponds to the number just above.
- **Channel type**: mic/line, analogue, digital, USB, MADI or AoIP.
- Indication of **MONO** or **STEREO** signal.
- In **mic/line** channels, indication of configuration as "MIC" or "LINE". See section **"2.2.3.6 MIC/LINE inputs"**.
- In **mic/line** channels configured as microphone, indication of **Phantom** power activated ("PHANTON") or deactivated ("PHANTOFF"). See section **"2.2.3.6. MIC/LINE inputs"**.

The contextual keys under the display are associated with the four options shown in the bottom line of the screen:

- **"BACK"**: pressing this key allows you to return to the previous menu screen.
- **"CFG"**: allows you to configure the mic/line channels as microphone or line and to activate/deactivate the Phantom power. This option only appears for that type of channels when the audio core edition is the one called **MCORE**.
- **"FADER"**: allows you to assign another input channel to the physical fader where this signal is currently found.
- **"ROUTE"**: gives you access to the menu for control and configuration of the internal routing of the equipment.

3.4.3.1.3.1. "CFG" menu.

This menu only appears in **mic/line** channels and when the audio core edition is the one called **MCORE**. It allows you to configure those channels as microphone or line and to activate/deactivate the Phantom power.



The operation of the contextual keys, from left to right, is as follows:

- **"BACK"**: pressing this key allows you to return to the previous menu screen.
- **"M/L"**: when the channel is configured as microphone enables you to change it to line and vice versa. When pressed the configuration is changed and it returns to the previous screen.
- **"PHM"**: when the Phantom power is deactivated enables you to activate it and vice versa. When pressed the configuration is changed and it returns to the previous screen. This key is only operative when the channel is configured as microphone.

Mic/Line inputs are configured as microphone with no Phantom feed by default.

3.4.3.1.3.2. "FADER" menu.

This menu is displayed as a list of all the inputs available in the system (except the ones that are yet assigned to a fader) and allows you to assign another input signal to the selected channel. It is also possible to access this menu by means of a long press (more than 2 seconds) of the "SELECT" key of the channel.



You can make your selection by turning any of the associated encoders and then pressing any of them or the "OK" contextual key to confirm the selection that is highlighted at that moment. The "BACK" contextual key allows you to return to the previous menu screen without changed the assigned signal.

3.4.3.1.3.3. "ROUTE" menu.

From this internal submenu you can manage the internal routing of signals in the console. You can access from the advanced information menu of an audio input channel and that submenu shows an alphabetical list of all of the outputs present in the console, followed by the internal summing buses ("Program", "Audition", "Aux1" and "Aux2"), the monitoring buses ("Cue", "Studio" and "Control") and finally the MPX buses.

The operation of the three associated encoders is as follows:

- Left: turning this encoder allows you to scroll through the several audio outputs and buses on the list. Pressing this encoder allows you to return to the previous menu screen (the changes you may have made are saved).
- Centre: turning this encoder has no associated function. Pressing this encoder allows you to return to the previous menu screen (the changes you may have made are saved).
- Right: turning this encoder enables you to modify the gain in the cross-point of the highlighted output or bus between -99.8dB and +24dB. By default, all of the cross-points will be configured with a 0dB gain. Pressing this encoder allows you to return to the previous menu screen (the changes you may have made are saved).



The operation of the contextual keys, from left to right, is as follows:

- **"BACK"**: pressing this key allows you to return to the previous menu screen (the changes you may have made are saved).
- **"ADD"**: enables you to create the cross-point toward the output signal or bus that is highlighted at that moment.
- **"DEL"**: enables you to delete the cross-point toward the output signal or bus that is highlighted at that moment.
- **"OK"**: pressing this key allows you to return to the previous menu screen (the changes you may have made are saved).

The routing toward the "Program" and "Audition" internal buses works in a different way depending on the assignment of the selected input to a fader or not:

- when the input is assigned to a fader and, in the previous list, you select "Program" bus (for instance), when you press the "ADD" key the routing key ("PROGRAM" in this case) of the channel is activated (the associated LED is lighted). In the display, the cross-point toward that bus appears for a moment and then disappears. The "DEL" key has no associated function in that case (you must press the "PROGRAM" channel key to deactivate that routing). If now you press the "ON" key of the channel, the cross-point appears now in the display (if you rise the fader, the "ON AIR" indicator will light); in that case, the "DEL" key allows you to deactivate the routing toward that bus (the cross-point disappears and the "PROGRAM" channel key turns off).
- when the input is not assigned to a fader and, in the previous list, you select "Program" bus (for instance), pressing the "ADD" key is equivalent to set that input "ON AIR" (the cross-point appears and, if gain is not configured at its minimum value, signal is sent to that bus). The "DEL" key allows you to deactivate that routing (the cross-point disappears).

It is possible to configure the operation mode of the sends to the internal summing buses in two ways, depending on whether the **"Pre-fader Sends"** option is activated or not (see section **4.2.8 "Options" submenu**). When this option is deactivated, the send level of a certain input to the system buses is linked to the fader, so that the variation of the channel fader affects those sends. When that option is activated, it's possible to unlink any of those sends from the channel fader; for this, the central encoder of the three located under the main display is used: by pressing it that send is activated/deactivated as pre-fader (when activated it is indicated by an arrow to the right inscribed in the cross point).



In the example, the send from "MIC 3" input to the summing bus "Aux 1" is linked to the fader (there is no arrow in the cross point) and the send to "Aux 2" is pre-fader (there is an arrow in the cross point).

3.4.3.2. "OUTPUT" menu.

This menu shows a list of all the audio output logical signals defined in the system from the configuration software, followed by the internal summing buses ("Program", "Audition", "Aux1" and "Aux2"), the monitoring buses ("Cue", "Studio" and "Control") and finally the MPX buses. For more information, see section **"4. CONFIGURATION SOFTWARE"** in this manual.

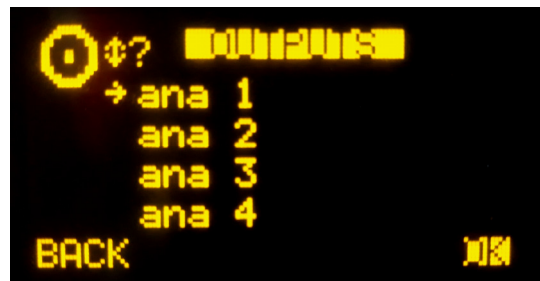

You can access a more detailed description of each one of the output audio channels by turning any of the 3 associated encoders and pressing then the "OK" contextual key or any of these encoders. The information showed on this screen, from top to bottom and left to right, is:

- **Name of the channel**, in alphanumeric format containing up to 6 characters.
- **Hardware** corresponding to the audio output of this channel, in format HW: xx.yy, where xx is the number of the virtual slot where this inputs/outputs module is installed, and yy is the audio channel of this inputs/outputs module. In stereo channels, yy represents the audio channel corresponding to the left channel of the stereo pair. The right channel corresponds to the number just above.
- Graphic representation of an **encoder** associated with the **GAIN** field. By turning the first associated encoder you can configure gain between -12dB and +12dB. The field is configured with the default value of 0dB.
- Indication of audio signal type: analogue, digital, USB, MADI or AoIP.
- Indication of **MONO** or **STEREO** signal.



The contextual keys under the display are associated with the three options shown in the bottom line of the screen:

- **"BACK"**: pressing this key allows you to return to the previous menu screen. The gain configuration you may have made is saved. You can also return to the previous screen by pressing any of the three associated encoders.
- **"TONE"**: controls the tone generator associated with that physical output. The tone generated is 1 KHz. Its activation is identified through the **LED** of the contextual key. To modify its level, you need only to change the output gain associated with that channel from the rotary encoder associated with "GAIN" control.
- **"ROUTE"**: this submenu allows you to manage the internal routing of the signals of the console toward that output signal or bus. It is displayed as a list of all the inputs channels connected to that output at that moment. By turning the first encoder you can go round the cross-points list. You can activate or deactivate the selected routing by means of "ADD" and "DEL" contextual keys and you can modify the cross-point gain (between -99.8dB and +24dB) by turning the third encoder.



4. CONFIGURATION SOFTWARE.

The AEQ FORUM LITE console is ready for use once the mixer inputs and outputs have been properly connected.

The console is shipped with the Audio inputs/outputs working. However, the name tags used for the channel audio inputs and outputs are generic (MIC 1, ANA 3, DIG 5 ...) and routing and effects programmed are AEQ standards that are used for functional testing of the console, whereas these settings may not be entirely to the preferences of the client.

This equipment is delivered with a Configuration Software for Windows 2000, XP, Vista, 7, 8 and 10.

This configuration software allows the user to modify the original configuration to its exact requirements at any time.

The auto run USB key furnished with the console contains the executable file that installs the configuration software. You can find it going through the following screens:



Installing the application is simply a matter of executing this file and following the on-screen instructions as they come up:

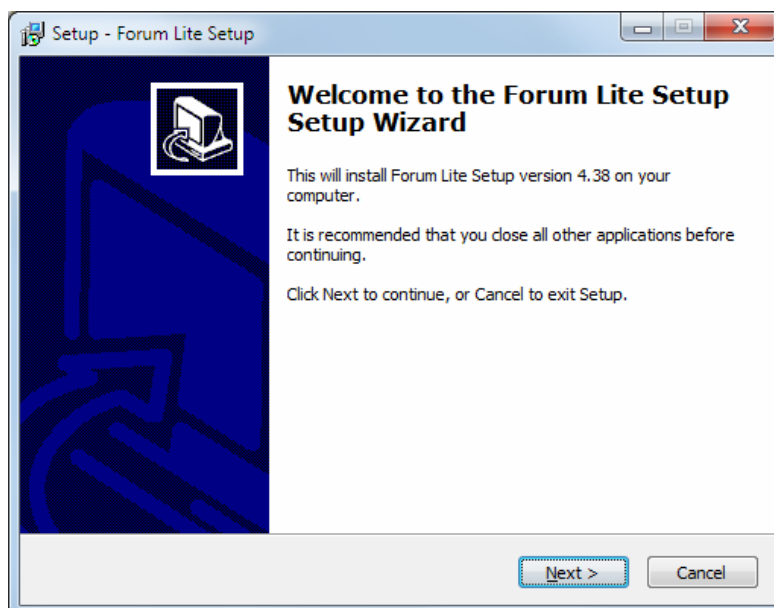

Once the "**Forum Lite Setup**" application is installed (by default, in C:\Program files\ForumLiteSetup), you can start it up by double-clicking the icon displayed on the desktop:



The configuration program will also be accessible from the Start menu.

When the application starts up, the access screen will appear asking user to introduce name and password.

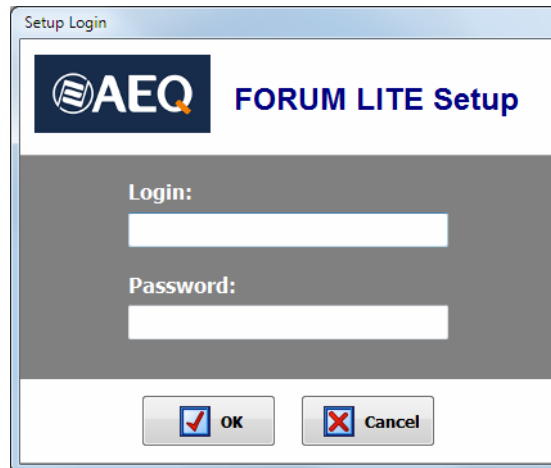

Only the users defined as administrators ("ADMINISTRATOR" access level) can access to this application. User and password supplied by default are:

Login: ADMIN
Password: 1234

You may modify these parameters later in the "Administration" → "User Configuration" menu of the application. Please refer to section 4.1.3 of this manual.

After entering the correct user-name and password, the program shows the main-screen where you can access the different options.

There are two main areas in this workspace:

- Left side of the screen: pull-down menus and submenu area.
- Right side of the screen: larger area containing parameter settings for each of the menus and submenus.

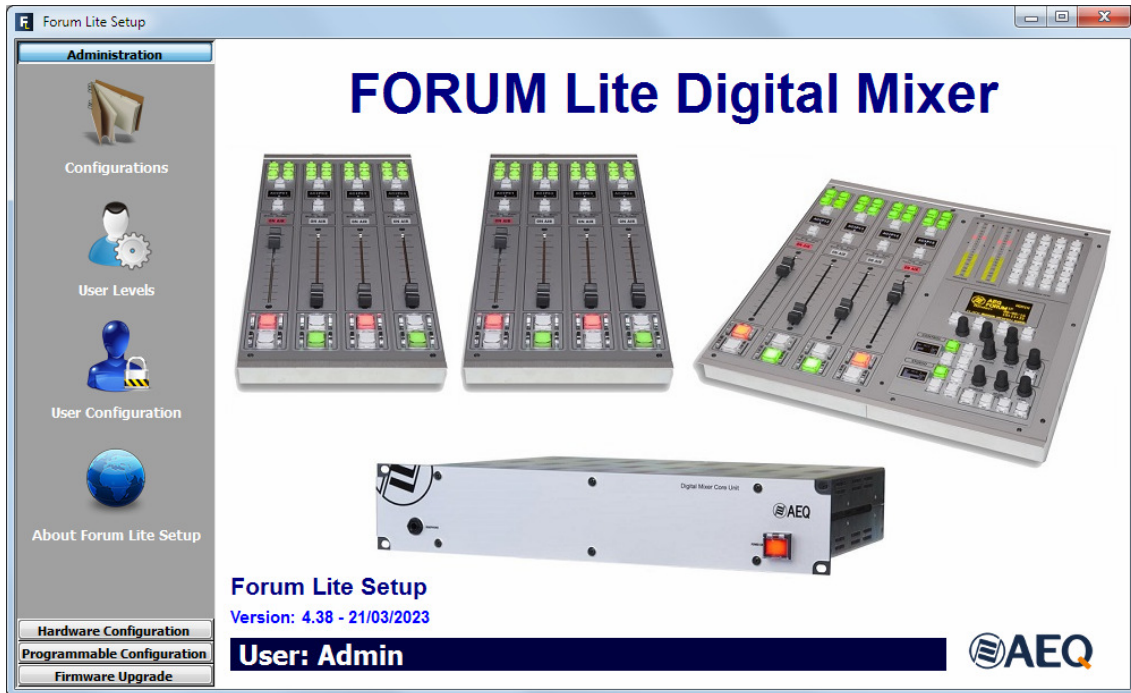

This initial screen shows information regarding the software version and the current user logged into the application. On the left side of the screen all the relevant menus and submenus are available. These are drop-down menus and are activated by clicking on the desired option.

The list of available menus is:

- **"Administration"**: allows you to manage the user levels and the authorized users of the mixing console and control the communication between the remote configuration software and the mixer.
- **"Hardware Configuration"**: allows you to configure the physical audio inputs and outputs and the logical audio channels that are created based on these. Further, the configuration of the monitoring sections, the "Visual Radio" functionality, the time synchronization, the vumeters transmission mode and the operation mode of the sends to the summing buses and of the channel activation keys are accomplished from here.
- **"Programmable Configuration"**: allows you to configure the internal routing of audio signals and the functions associated with the programmable keys, as well as define mics groups, create processes presets and manage the configuration memories (snapshots) of the unit.
- **"Firmware Upgrade"**: is a maintenance menu to accomplish firmware upgrades of the mixer.

To exit the application, simply press the exit icon located in the upper right corner of the screen. The application will ask for confirmation.

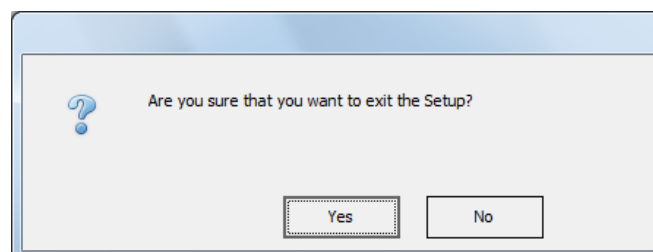

4.1. "Administration" menu.

This menu allows you to manage levels of users that can operate the mixer and control the communication between the remote configuration software and the mixer. Clicking on the "Administration" section of the main screen the complete list of submenus is shown:

- **"Configurations"**: allows you to manage the configuration exchange between the software application and the AEQ FORUM LITE.
- **"User Levels"**: allows you to define the user levels to operate the AEQ FORUM LITE mixing console.
- **"User Configuration"**: allows you to define the users with access to operate the AEQ FORUM LITE mixing console.
- **"About Forum Lite Setup"**: this screen shows information regarding the software version and the current user logged into the application.

4.1.1. "Configurations" submenu.

"Configurations" submenu is accessed, from the drop-down menu "Administration", by clicking on the icon:



"Configurations" submenu handles the exchange of configurations created in the software application between this software and the connected mixer.

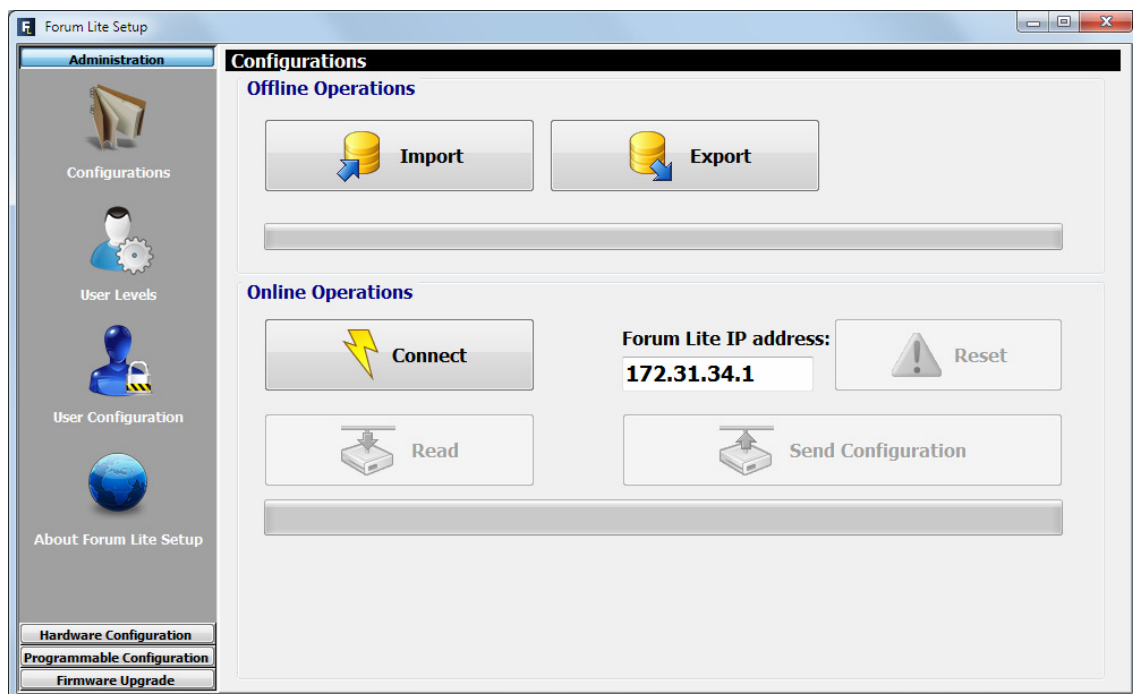

There are two distinct areas in this submenu:

- **"Offline Operations"**: allows you to execute actions where it is not necessary that the "Forum Lite Setup" application is in direct communication with the AEQ FORUM LITE mixer. Two actions are available:

- **"Import"**: allows you to load in the application complete configurations previously stored in a source file. By clicking the "Import" button, a standard Windows "browse for file" window will open to locate the file to import. The files must be of the proprietary type **LSC** (Lite Setup Configuration). These files are encrypted for reasons of security.

You can find the "DemoConfiguration.LSC" file in C:\Program files \ForumLiteSetup\Demos.

IMPORTANT NOTE: when you load a configuration using this option, the active configuration at that moment in the application is overwritten and get lost (unless you previously save it by means of "Export" option). Therefore, you will be asked for confirmation:

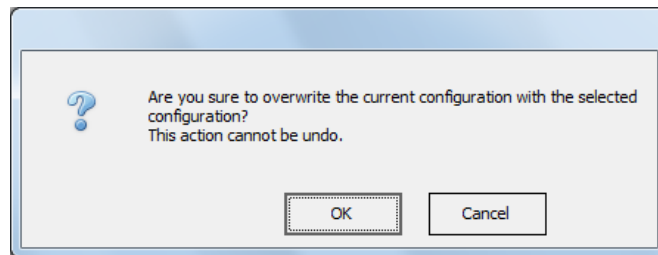

- **"Export"**: allows you to download the complete configuration, as shown in the application at any given moment, to a target file. Clicking on the "Export" button a standard Windows "save as" window will open allowing you to choose the folder and output file name to be stored. These files will have the **LSC** extension.
- **"Online Operations"**: allows you to execute actions where it is necessary that the "Forum Lite Setup" application is in direct communication with the AEQ FORUM LITE mixer, which "LAN" port, located on the rear panel of the mixer, has the default IP address **172.31.34.1** displayed on the screen.

The "Connect" button initiates the communication process between the "Forum Lite Setup" application and the AEQ FORUM LITE Mixer. If the connection is established correctly the 3 associated buttons become active and the "Connect" button changes to "Disconnect" (and allows you to end that communication). In addition, the "AOIP" and "Licenses" options appear in the lower part of this area.

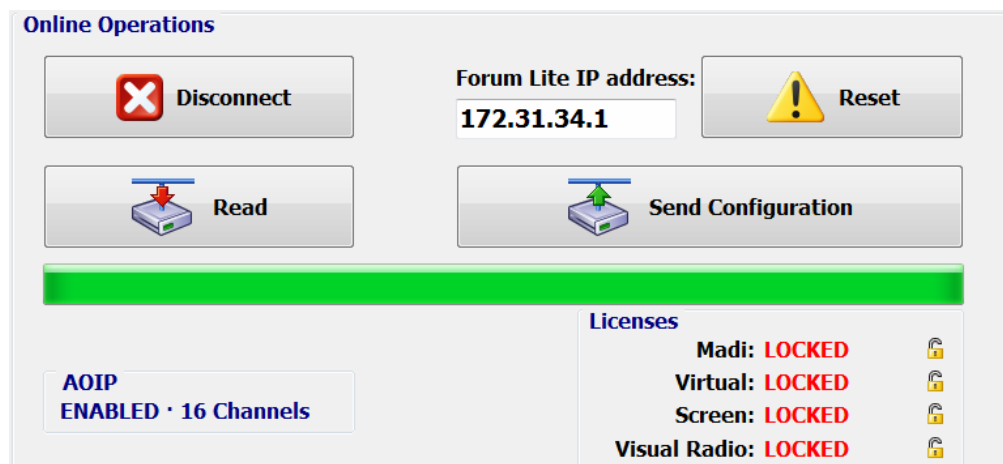

In case there is no connection to the mixer, those options are not activated and the following message is displayed:

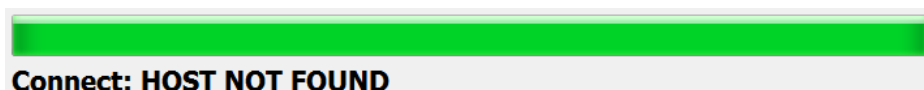

The associated buttons functions are the following ones:

- **"Read"**: allows you to read the configuration currently active in the AEQ FORUM LITE mixer and download it in the "Forum Lite Setup" application.
IMPORTANT NOTE 1: the active configuration at that moment in the application is overwritten and get lost (unless you previously save it by means of "Export" option).
IMPORTANT NOTE 2: the routing toward MPX internal summing buses is saved on console configuration and it will appear in the "Routing Configuration" submenu when the active configuration is read.
- **"Send Configuration"**: allows you to send the currently selected configuration to the AEQ FORUM LITE mixing console, thus becoming the valid configuration in operation. The audio will be interrupted a few seconds while the new configuration is being activated. During the sending, a bar shows the process. If the process is properly done, the message **"Send Configuration: OK"** is displayed.
- **"Reset"**: replaces the currently active configuration on the AEQ FORUM LITE mixing console with the configuration stored in the first memory or snapshot defined (please refer to section 4.3.5 of this manual). The audio will be interrupted a few seconds while the new configuration is being loaded (unless in that first memory the ON AIR channel or channels are placed in the same fader positions).
- **"AOIP"**: this section informs you whether the AoIP (audio over IP) function is **"ENABLED"** at physical level or not (**"DISABLED"**). When enabled, it also indicates if the installed hardware allows to use a maximum of **16** or **32** AoIP channels.
- **"Licenses"**: allows you to activate the MADI link and/or the "Forum Lite Virtual" and "Forum Lite Screen" applications functionality, as well as the "Visual Radio" functionality. For any of the 4 options, you must purchase a user license.

When you press the padlock associated with any of the 4 options, a window will appear allowing you to introduce the key associated with the corresponding functionality.

For MADI functionality:

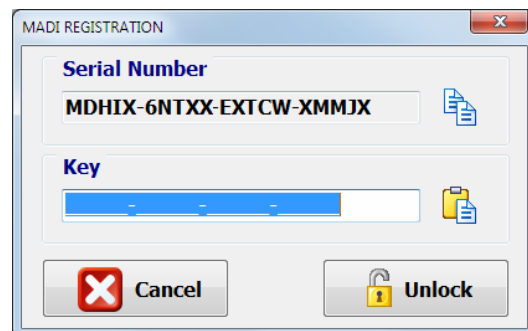

for the "Forum Virtual" application (available in future versions):

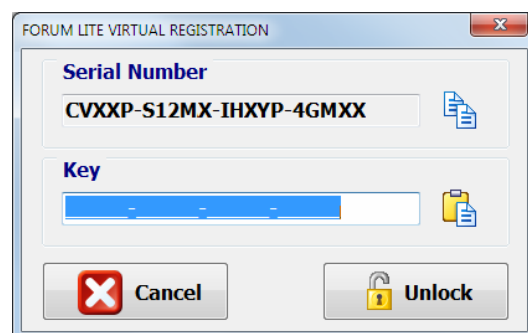

for the "Forum Lite Screen" application (available in future versions):

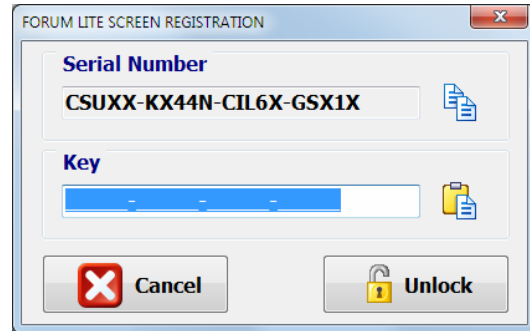

or for the "Visual Radio" functionality:

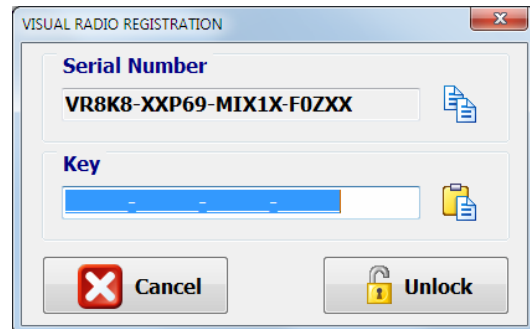

In case your order includes any of those functionalities, the console is supplied from Factory with the functionality activated. If you want to activate it a posteriori, you must copy the "Serial Number" by means of the associated button and send it to AEQ in order to generate the associated "Key" and send it back to you (you must paste it by means of the associated button).



The "Unlock" button allows you to confirm the key and, when it's correct, activate the function.

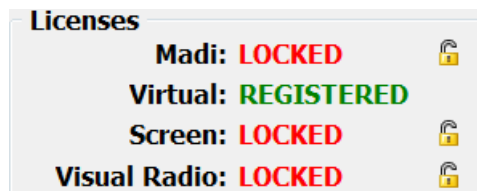

In case the key is not the right one, a warning message will appear:

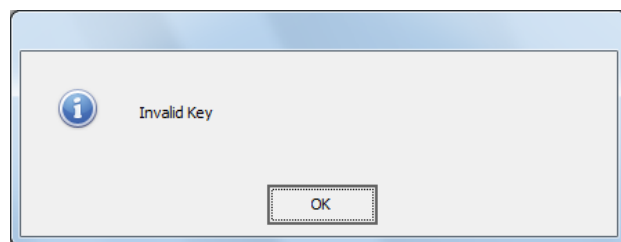

IMPORTANT NOTE: MADI functionality is not compatible with **AoIP** (audio over IP) functionality, both options can't be active at the same time.

4.1.2. "User Levels" submenu.

"User Levels" submenu is accessed, from the drop-down menu "Administration", by clicking on the icon:

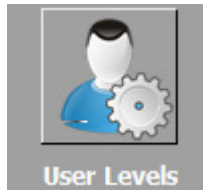

"User Levels" submenu allows you to define the user levels to operate the AEQ FORUM LITE mixing console. Within this submenu there are two distinct areas on the screen:

- The left side shows the list of created user levels.
- The right side shows the list of the permissions that are part of the level selected at that moment in the left part of the screen.



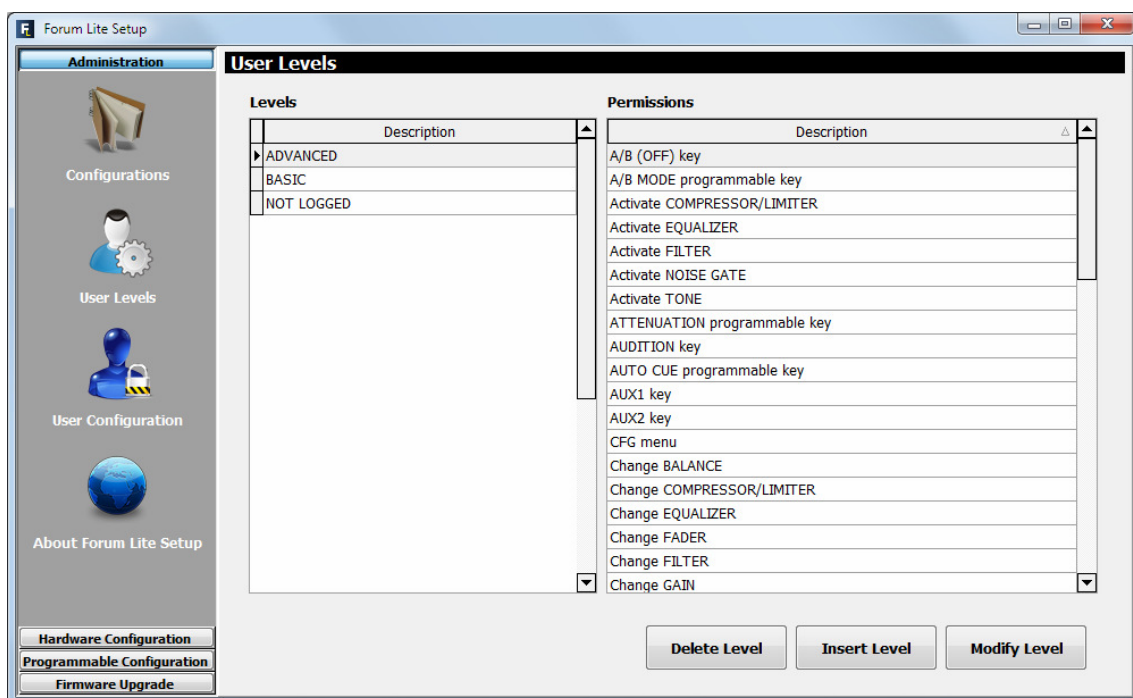

There are 4 user levels defined by default in the AEQ FORUM LITE mixing console: "ADMINISTRATOR", "ADVANCED", "BASIC" and "NOT LOGGED". The "ADMINISTRATOR" level has all the available permissions and does not appear in the list on the left because it cannot be modified or deleted. The "NOT LOGGED" level, which is accessed by pressing the "LOGOU" contextual key in the console's initial menu, can be modified but not deleted. Up to 13 more levels can be defined.

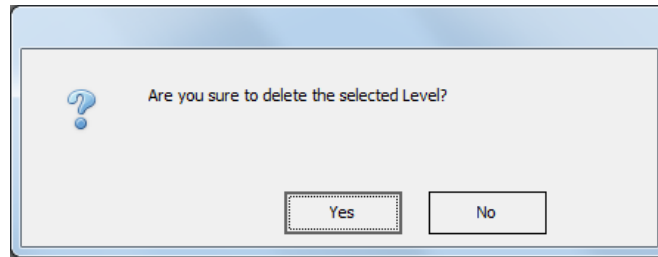

The three buttons at the bottom of the screen allow you to manage the list of user levels and their individual configuration.

- **"Delete Level"**: deletes the selected user level. Confirmation is requested. As previously indicated, the "NOT LOGGED" level cannot be deleted. When a level is associated with a certain user, it cannot be deleted until that user is deleted or a different level is associated with it.



- **"Insert Level"**: allows you to create a new user level and select the permissions to be included through the following menu options:
 - **"Level"**: name for the user level.
 -  adds ALL permissions from the "Available permissions" column to the "Level permissions" column.
 -  adds ONLY the permission selected from the "Available permissions" column to the "Level permissions" column.
 -  removes ONLY the permission selected from the "Level permissions" column back to the "Available permissions" column.
 -  removes ALL the permissions from the "Level permissions" column back to the "Available permissions" column.
 - **"OK"**: allows you to accept the created or edited configuration.
 - **"Cancel"**: allows you to reject the created or edited configuration. No change you may have made is saved.

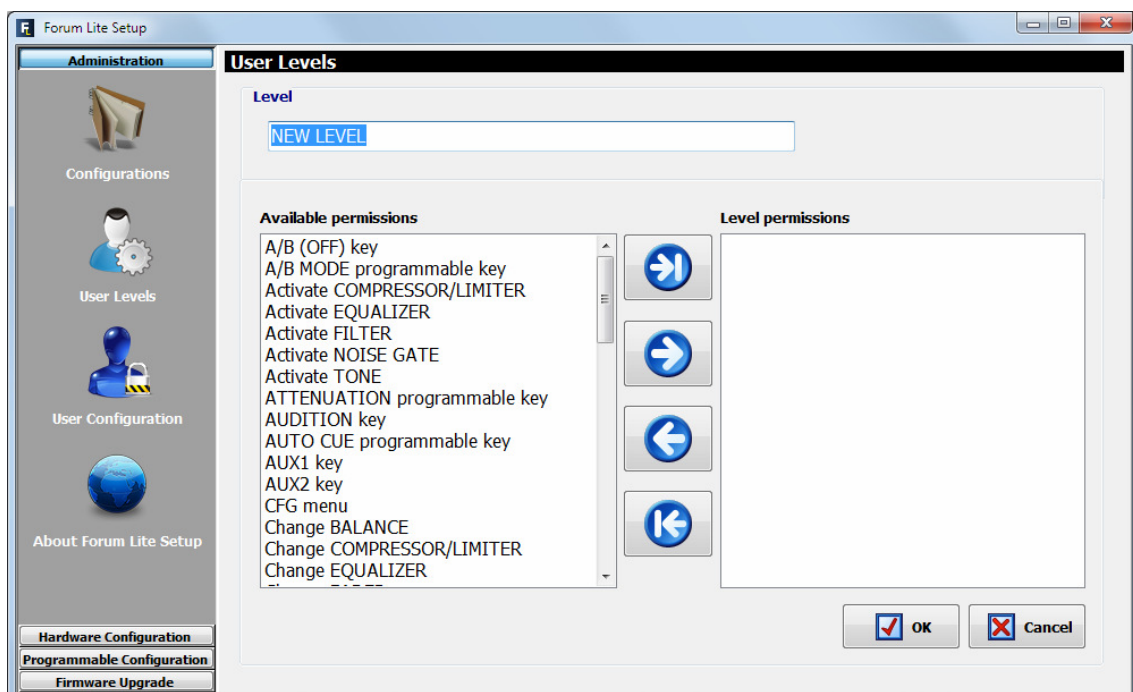

- **"Modify Level"**: allows you to modify the selected and previously created user level. The menu is identical to previously described for "Insert Level" option.

The available permissions are the following ones:

- "A/B (OFF) key": allows to activate the channel OFF key when it works in A/B mode.
- "A/B MODE programmable key": allows to activate/deactivate the "A/B Mode" type programmable key.
- "Activate COMPRESSOR/LIMITER": allows to activate/deactivate the compressor/limiter.
- "Activate EQUALIZER": allows to activate/deactivate the equalizer.
- "Activate FILTER": allows to activate/deactivate the filter.
- "Activate NOISE GATE": allows to activate/deactivate the noise gate.
- "Activate TONE": allows to activate/deactivate the test tone.
- "ATTENUATION programmable key": allows to activate/deactivate the "Studio Monitor Attenuation" type programmable keys.
- "AUDITION key": allows to activate/deactivate the "AUDITION" direct routing key.
- "AUTO CUE programmable key": allows to activate/deactivate the "Auto Cue" type programmable key.
- "AUX1 key": allows to activate/deactivate the "AUX1" direct routing key.
- "AUX2 key": allows to activate/deactivate the "AUX2" direct routing key.
- "CFG menu": allows to access the "CFG" menu and activate/deactivate the available options of that menu.
- "Change BALANCE": allows to modify the signal balance.
- "Change COMPRESSOR/LIMITER": allows to change the configuration parameters of the compressor/limiter.
- "Change EQUALIZER": allows to change the configuration parameters of the equalizer.
- "Change FADER": allows fader position changes to vary the signal level.
- "Change FILTER": allows to change the configuration parameters of the filter.
- "Change GAIN": allows to modify the signal gain.
- "Change IP ADDRESS": allows to access the "IPSET" option of "SETUP" menu and modify the console IP address.
- "Change NOISE GATE": allows to change the configuration parameters of the noise gate.
- "Change PHASE": allows to modify the signal phase.
- "Change ROUTING": allows to modify the signal routing.
- "Change SEL signal in CONTROL": allows to change the signal associated to "SEL" key of control monitoring.
- "Change SEL signal in STUDIO": allows to change the signal associated to "SEL" key of studio monitoring.
- "Change SIGNAL": allows to change the signal assigned to a certain channel.
- "CLOCK menu": allows to access the "CLOCK" menu and activate/deactivate the available options of that menu.
- "CODEC programmable key": allows to activate/deactivate the "Codec" type programmable keys.
- "CONTROL headphones level": allows to modify the level of the control monitoring headphones.
- "CONTROL monitor level": allows to modify the level of the control monitoring speakers.
- "CONTROL MONITORING keys": allows to activate/deactivate the selection keys of the control monitoring.
- "CUE key, CUE level & CUE RESET": allows to activate/deactivate the "CUE" channel keys, modify the level of the CUE speakers and press the "CUE RESET" key.
- "CUE RESET programmable key": allows to activate/deactivate the "Cue Reset" type programmable key.
- "GENERAL programmable key": allows to activate/deactivate the "General" type programmable keys.
- "GPO (OFF) key": allows to activate the channel OFF key when it works in GPO mode.
- "INPUTS menu": allows to access the console inputs menu.
- "Load SNAPSHOTS": allows to load the selected configuration memory or snapshot.
- "MEMORY menu": allows to access the "MEMORY" menu with the system configuration memories or snapshots.

- "MEMORY programmable key": allows to activate/deactivate the "Memory" type programmable keys.
- "MAIN MENU": allows to access the console advanced configuration menu.
- "MULTIPLEX programmable key": allows to activate/deactivate the "Multiplex" type programmable keys.
- "OFF key": allows to activate the channel deactivation key.
- "ON key": allows to activate the channel activation key.
- "ORDERS (OFF) key": allows to activate the channel OFF key when it works in ORDERS mode.
- "ORDERS programmable key": allows to activate/deactivate the "Orders" type programmable keys.
- "OUTPUTS menu": allows to access the console outputs menu.
- "PROGRAM key": allows to activate/deactivate the "PROGRAM" direct routing key.
- "SALVO programmable key": allows to activate/deactivate the "Salvo" type programmable keys.
- "Save SNAPSHOTS": allows to store in the selected configuration memory or snapshot the configuration of the console at that moment.
- "SELECT key": allows to activate/deactivate the "SELECT" channel key.
- "STUDIO headphones level": allows to modify the level of the studio monitoring headphones.
- "STUDIO monitor level": allows to modify the level of the studio monitoring speakers.
- "STUDIO MONITORING keys": allows to activate/deactivate the selection keys of the studio monitoring.
- "TALKBACK keys": allows to activate/deactivate the Talkback section keys.
- "TALKBACK level": allows to modify the Talkback microphone gain.
- "TO MIXER BUS programmable key": allows to activate/deactivate the "To Mixer Bus" type programmable key.

In some cases, it's necessary to assign several permissions to a certain level in order to perform certain options.

For example, if we assign the "Load SNAPSHOTS" (or "Save SNAPSHOTS") permission to a user level, we must also assign the "MEMORY menu" permission to be able to access the menu where any of these two options are executed.

Another example is given if we assign the "Activate TONE" permission to a user level: in this case, we must also assign the "MAIN MENU" and "OUTPUTS menu" permissions to be able to access the menu where that test tone can be activated/deactivated.

Another example is given if we assign the "A/B (OFF) key", "GPO (OFF) key" or "ORDERS (OFF) key" permission to a user level: in this case, we must also assign the "OFF key" permission to be able to activate any of the previous options.

4.1.3. "User Configuration" submenu.

"User Configuration" submenu is accessed, from the drop-down menu "Administration", by clicking on the icon:

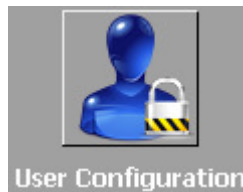

"User Configuration" submenu allows you to define the users (and associate them a certain level) with access to operate the AEQ FORUM LITE mixing console.

The display in this submenu shows the list of registered users and their associated parameters:

- **"User"**: alphanumeric name of the user. The maximum number of digits is limited to 32. In the upper right part of the main display the name of the active user at that moment is shown.
- **"Password"**: password associated with the user: number combination of up to 32 digits from zero to nine, although a **maximum of 6 digits** is recommended (a password with more than 6 digits could be used just to access the software, but couldn't be used in the console). This password is used to access all the permitted actions in advanced menu, from the main screen of the Control and Monitoring section of AEQ FORUM LITE. For more information see section 3.2 of this manual.
- **"Access Level"**: user level associated with the name and password previously configured (you can check the password associated with a user by means of edition button). AEQ FORUM LITE allows up to 17 different user levels.







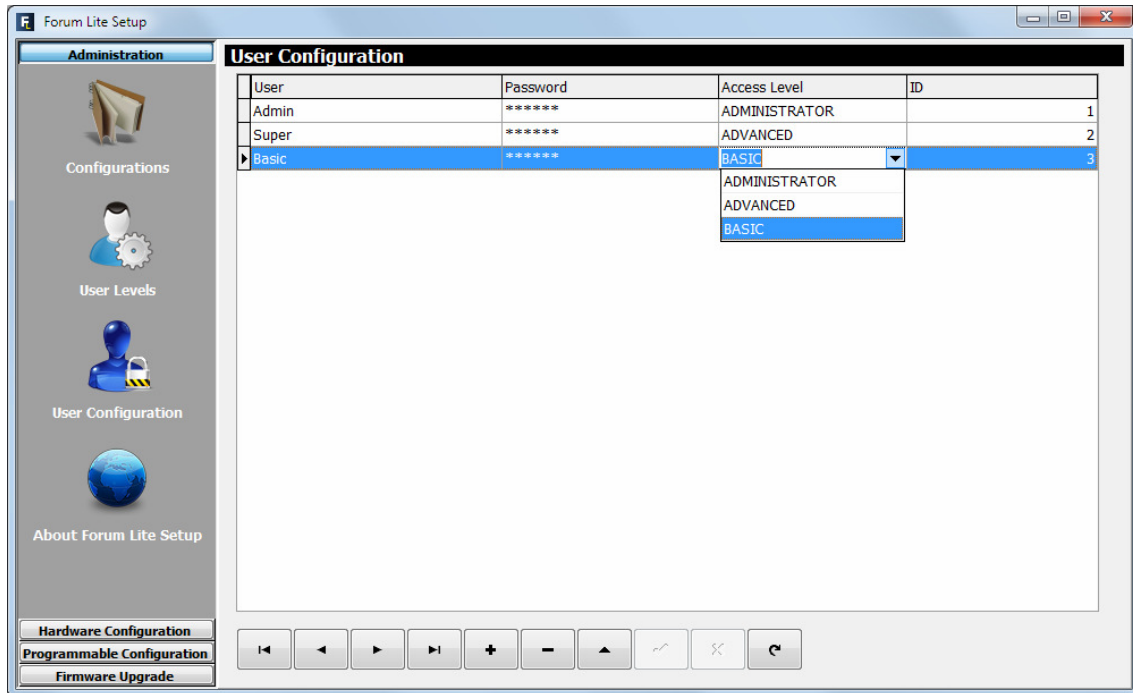



There are 4 user levels defined by default in the console: "ADMINISTRATOR", "ADVANCED", "BASIC" and "NOT LOGGED". The "ADMINISTRATOR" level has all the available permissions. The "NOT LOGGED" level cannot be selected in the "Access Level" column: it corresponds to a generic user with no associated password, which is accessed by pressing the "LOGOU" contextual key in the console's initial menu.

The permissions associated with each user level can be checked in the "User Levels" submenu of the application. Section 4.1.2 of this manual details this submenu, as well as the process for creating and modifying the system user levels.

- **"ID"**: internal reference number for each user automatically and sequentially assigned.



The lower part of the "User Configuration submenu includes a set of standardized buttons to manage the list of registered users:

- 
Allows you to scroll to the top of the list.
- 
Allows you to move to the position immediately above in the list.
- 
Allows you to move to the position immediately below in the list.
- 
Allows you to scroll to the last position of the list.
- 
Allows you to insert a new entry in the list.
- 
Allows you to delete the selected entry from the list. Confirmation is requested.
- 
Allows you to edit the selected entry and check the password associated with that user.
- 
Allows you to accept changes to the selected entry.
- 
Allows you to reject changes to the selected entry.
- 
Allows you to refresh the information shown in the list.

4.1.4. "About Forum Lite Setup" submenu.

"About Forum Lite Setup" submenu is accessed, from the drop-down menu "Administration", by clicking on the icon:



"About Forum Lite Setup" submenu simply shows information regarding the software version and the current user logged into the application.



4.2. "Hardware Configuration" menu.

This menu allows you to configure the system inputs and outputs modules as well as the logical audio channels created from the physical inputs and outputs. Clicking on the "Hardware Configuration" section on the left side of the screen displays the full list of submenus, which includes:

- **"Board Configuration"**: allows you to configure the MAD1 and AoIP functionalities, the remote sync extraction and the console GPIOs, as well as define the faders setting and the digital nominal level. Reports the virtual configuration regarding number of faders and audio inputs/outputs modules.
- **"Mixer Bus Configuration"**: allows you to define the configuration of the internal summing buses of the mixing console.
- **"I/O Configuration"**: enables the configuration of logical audio channels based on the physical audio inputs and outputs of the system.
- **"Monitoring Configuration"**: allows you to define the operation of the Control and Monitoring sections that are associated with the control and studio rooms.
- **"Visual Radio"**: allows you to configure the "Visual Radio" functionality.
- **"NTP Client"**: allows you to configure and activate time and date synchronization with a remote NTP server. Once configured this server will work as the master clock for the local time of the AEQ FORUM LITE.

- **"Vumeters"**: allows you to configure the vumeters transmission mode.
- **"Options"**: allows you to configure the operation mode of the sends to the summing buses and of the channel activation keys.

In order to access to any of these submenus, it's necessary to have a configuration loaded in the application: in case there's no configuration, the message **"Empty configuration. Please read configuration before use"** would be displayed and you should have to either connect to AEQ FORUM LITE console and read its configuration or load a configuration by means of "Import" option (see section 4.1.1 of this manual; you can find the "DemoConfiguration.LSC" file in C:\Program files\ForumLiteSetup\Demos).

4.2.1. "Board Configuration" submenu.

"Board Configuration" submenu is accessed, from the drop-down menu "Hardware Configuration", by clicking on the icon:

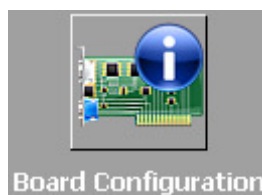

"Board Configuration" submenu enables you to check the faders and inputs/outputs configuration and to define the MADi and AoIP functionalities and the GPIOs configuration.

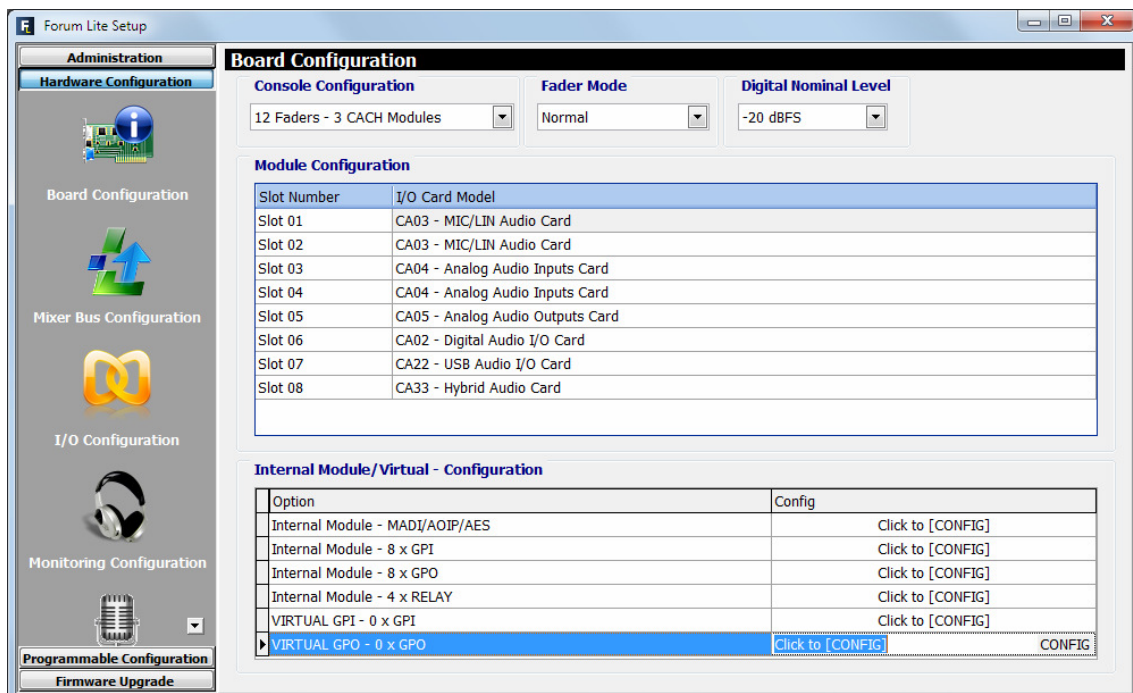

The screenshot shows the "Forum Lite Setup" application window. The "Board Configuration" submenu is selected in the left-hand navigation pane. The main window displays the following configuration options:

- Console Configuration:** 12 Faders - 3 CACH Modules
- Fader Mode:** Normal
- Digital Nominal Level:** -20 dBFS

Module Configuration Table:

Slot Number	I/O Card Model
Slot 01	CA03 - MIC/LIN Audio Card
Slot 02	CA03 - MIC/LIN Audio Card
Slot 03	CA04 - Analog Audio Inputs Card
Slot 04	CA04 - Analog Audio Inputs Card
Slot 05	CA05 - Analog Audio Outputs Card
Slot 06	CA02 - Digital Audio I/O Card
Slot 07	CA22 - USB Audio I/O Card
Slot 08	CA33 - Hybrid Audio Card

Internal Module/Virtual - Configuration Table:

Option	Config
Internal Module - MADi/AoIP/AES	Click to [CONFIG]
Internal Module - 8 x GPI	Click to [CONFIG]
Internal Module - 8 x GPO	Click to [CONFIG]
Internal Module - 4 x RELAY	Click to [CONFIG]
VIRTUAL GPI - 0 x GPI	Click to [CONFIG]
VIRTUAL GPO - 0 x GPO	Click to [CONFIG] CONFIG

From left to right and from top to bottom the available options are:

- **"Console Configuration"**: allows you to define the number of 4 faders modules in AEQ FORUM LITE control surface.
- **"Fader Mode"**: allows you to configure the position of the nominal operating level (+0dB) of the console faders. When "Normal" option is selected that level is placed at the third band from above, while when "Full Throw" is selected that level is placed at the upper position of fader.

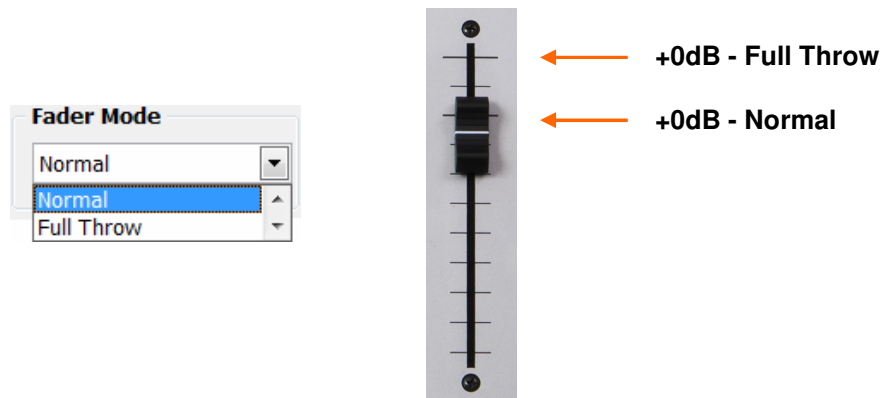

- **"Digital Nominal Level"**: allows you to configure the digital nominal level of the console. By default, the nominal level of AEQ consoles for digital signals is **-20dBFS**. There is an adjustment margin of +/-12dB by means of gains configuration.

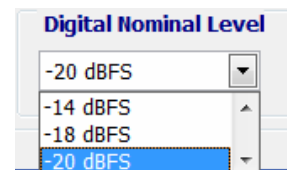

By means of the drop-down menu it's possible to modify the digital nominal level to **-14dBFS** or **-18dBFS**. There is also an adjustment margin of +/-12dB.

- **"Module Configuration"**: informative maintenance field: shows information about the input and output logical modules at AEQ FORUM LITE back panel.
- **"Internal Module/Virtual - Configuration"**: allows you to configure the general purpose inputs and outputs GPIO (the physical contact relays, the opto-coupled and the virtual GPIOs). It also allows you to configure the operation of the optional multichannel AES10 MADi communications module (available by means of user license: see section 4.1.1 of this manual), the operation of the multichannel interface AoIP and the remote sync extraction.

4.2.1.1. "Internal Module/Virtual - Configuration" section.

"Internal Module/Virtual - Configuration" section of "Board Configuration" submenu allows you to configure the physical general purpose inputs and outputs **GPIO** (both the physical contact relays and the opto-coupled) that are available on the rear panel of the AEQ FORUM LITE (please refer to section 2.2.2.1 of this manual), as well as the virtual GPIOs.

It also allows to configure the operation of the optional multi-channel AES10 **MADI** communications module (please refer to section 2.2.4.1 of this manual; **NOTE**: this module is available only by means of user license), the operation of the multichannel interface **AoIP** and the remote sync extraction.

IMPORTANT NOTE: MADI and AoIP (audio over IP) functionalities are not compatible, both options can't be active at the same time.

There are six distinct areas in this section:

1. **MADI/AOIP/AES**: allows you to configure MADI and AoIP functionalities and the remote sync extraction. The advanced configuration menu of this optional module is accessed by clicking **"Click to [CONFIG]"** and then clicking again on the **"CONFIG"** button that will appear. A window with 3 tabs will appear. **NOTE**: in order to change from MADI tab to AOIP tab the first one must be "Disabled", and the same happens to change from AOIP to MADI.
 - **MADI**: is an optional communication module within the system common I/O section (available by means of user license: see section 4.1.1 of this manual). This is a bi-directional fiber-optic multi-channel audio link. The physical interface is a transceiver and the implemented standard is AES10-2003. The configuration options are:

- **"Disable/Enabled"**: deactivates or activates the module.
- **"Sync"**: allows you to configure whether the console will use the synchronism extracted from MADI link ("Slave") or not ("Master").
- **"Used"**: allows you to configure how many of the 64 mono channels available are actually in use.

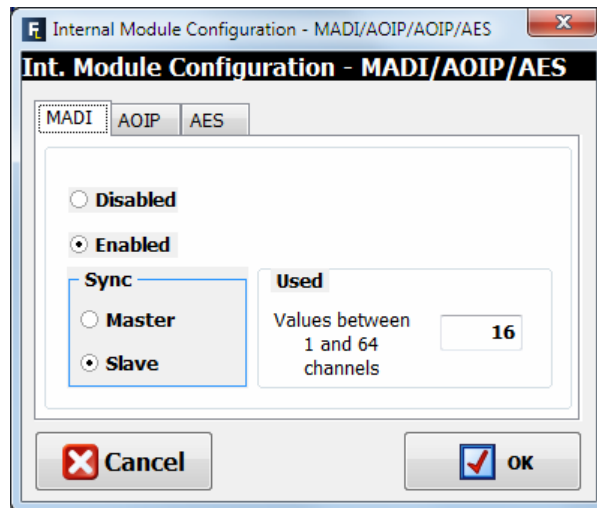

- **AOIP**: this module provides up to 16 (or 32, depending on hardware) mono input and output audio channels. The configuration options are:
 - **"Disabled / 16 Channels / 32 Channels"**: deactivates or activates the module (up to 16 or up to 32 channels).
 - **"Sync"**: allows you to configure whether the console will use the synchronism extracted from AoIP link ("Slave") or not ("Master").
 - **"Used"**: allows you to configure how many of the 16 (or 32) mono channels available are actually in use.

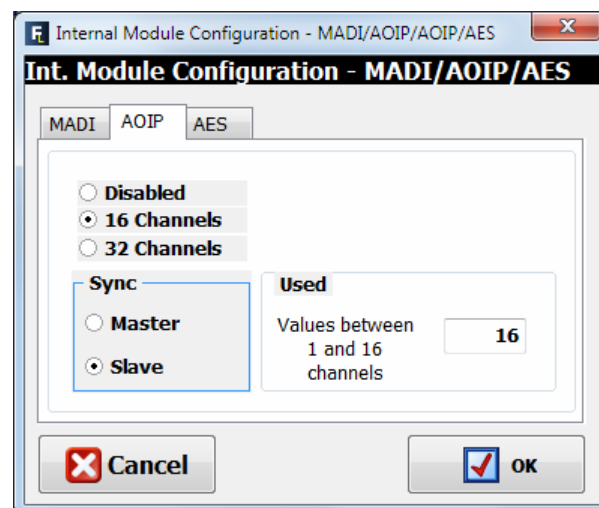

- **AES**: this section allows you to configure if you want to synchronize the console using the external synchronism received in AES11 format through **digital input 1** of **"AES IN 1-4/SYNC"** connector (see section 2.2.3.2): in that case, you must configure this option as **"Slave"**. It's not possible to use WORD CLOCK external synchronism.

When this option is configured as "Slave" and there is an AES11 external synchronism valid signal in that digital input 1, this synchronization **prevails** over external synchronization through multichannel link (MADI or AoIP); when there is no AES11 valid signal, then external synchronization can be extracted from multichannel link where "Slave" mode is configured.

When the used multichannel link and the "AES" section are configured as "Master" and/or there is no external synchronism input, then synchronism is local and the console internal oscillator is used.

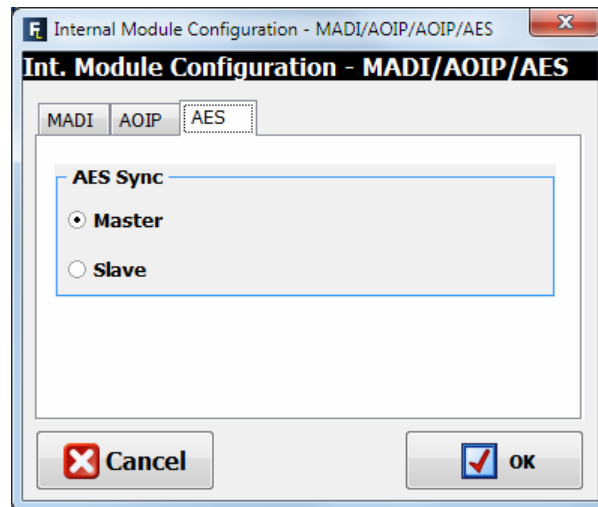

2. **GPI:** General Purpose Inputs. AEQ FORUM LITE incorporates 8 opto-coupled GPI's on open-collector transistors.

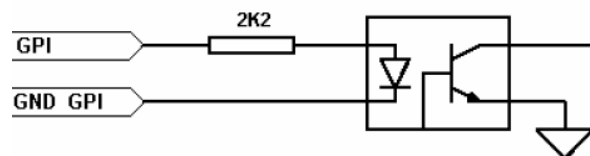

The advanced configuration menu of GPIs is accessed by clicking "**Click to [CONFIG]**" and then clicking again on the "**CONFIG**" button that will appear. The configuration options are:

- Edit the "Label" to identify the assigned role.
- Configure the working mode ("Level" column) of each GPI. The options are:
 - "High": GPI activated on high level.
 - "Low": GPI activated on low level.
 - "On Change": GPI activated by transitions from high to low or the inverse.
 - "TH02": GPI to accept the particular signalling that is generated by the AEQ TH-02EX MkII digital hybrid, as well as to enable the remote control of this particular equipment.

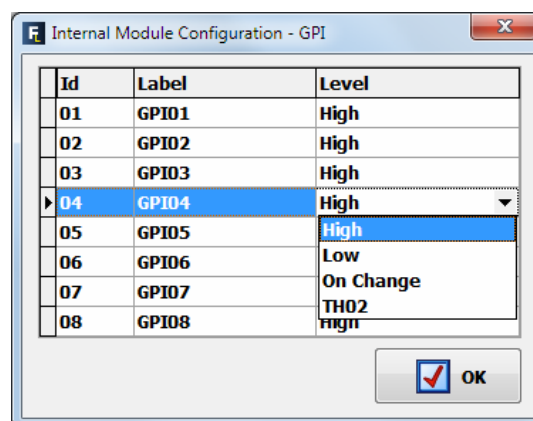

- GPO:** General Purpose Outputs. AEQ FORUM LITE incorporates 8 opto-coupled GPO's on open collector transistors.

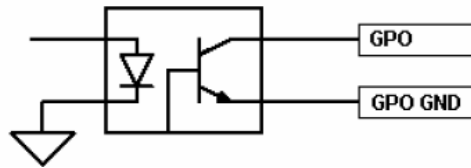

The advanced configuration menu of GPOs is accessed by clicking "**Click to [CONFIG]**" and then clicking again on the "**CONFIG**" button that will appear. The configuration options are:

- Edit the "Label" to identify the assigned role.
- Configure the working mode ("Level" column) of each GPO. The options are:
 - "Level High": GPO activated on high level.
 - "Level Low": GPO activated on low level.
 - "On Change": GPO is activated by transitions from high to low or the inverse.
 - "Pulse High": output in the form of a high level pulse with a duration that is defined in milliseconds in the field "Duration".
 - "Pulse Low": output in the form of a low level pulse with a duration that is defined in milliseconds in the field "Duration".

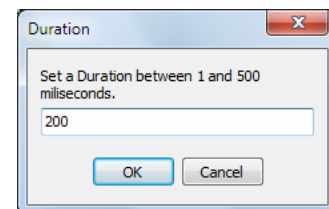
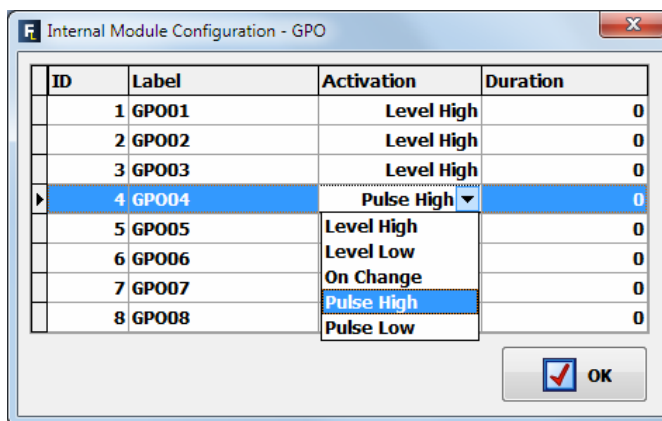

- RELAY:** allows you to configure the GPO outputs on physical contact relays as opposed to the opto-coupled GPO's on open collector transistors. There are four contact relays or contacts.

The advanced configuration menu of GPOs is accessed by clicking "**Click to [CONFIG]**" and then clicking again on the "**CONFIG**" button that will appear. This configuration menu is exactly like the previously detailed for GPOs.

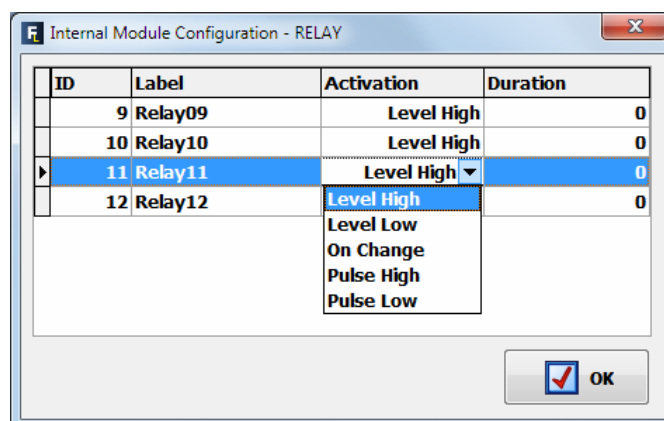

5. **VIRTUAL GPI:** allows you to configure the Virtual GPIs, General Purpose Inputs that come into the unit through an IP connection. Up to **246** virtual GPIs can be configured.

The advanced configuration menu of Virtual GPIs is accessed by clicking "**Click to [CONFIG]**" and then clicking again on the "**CONFIG**" button that will appear.

The window that appears allows you to create and edit virtual GPIs.

The available options of this configuration window are:

- **IP: optional** field that allows you to edit the IP address in order to define the origin of the received orders.
- **Id Number:** allows you to assign an order number to virtual GPI into the unit, that must be less than 256. Id Number can not be duplicate.
- **Label:** allows you to assign a label to virtual GPI in order to identify it into the unit. When no label is assigned, it's identified as "Virtual GPI *Id Number - IP*".

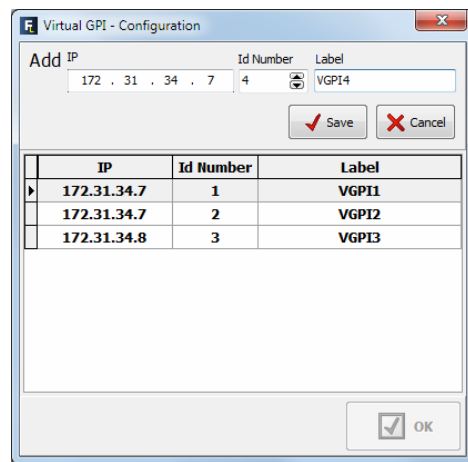
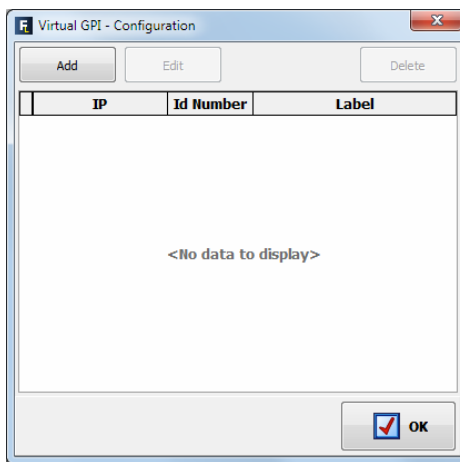

6. **VIRTUAL GPO:** allows you to configure the Virtual GPOs, General Purpose Outputs that are sent to other units through an IP connection. Up to **242** virtual GPOs can be configured.

The advanced configuration menu of Virtual GPIs is accessed by clicking "**Click to [CONFIG]**" and then clicking again on the "**CONFIG**" button that will appear.

The window that appears allows you to create and edit virtual GPOs.

The available options of this configuration window are:

- **IP: mandatory** field that allows you to edit the IP address in order to define the destination of the generated orders.
- **Id Number:** allows you to assign an order number to virtual GPO into the unit, that must be less than 256. The same virtual GPO can be sent to different units, in that case the same Id Number must be assigned to different IP addresses.
- **Label:** allows you to assign a label to virtual GPO in order to identify it into the unit. When no label is assigned, it's identified as "Virtual GPO *Id Number - IP*".

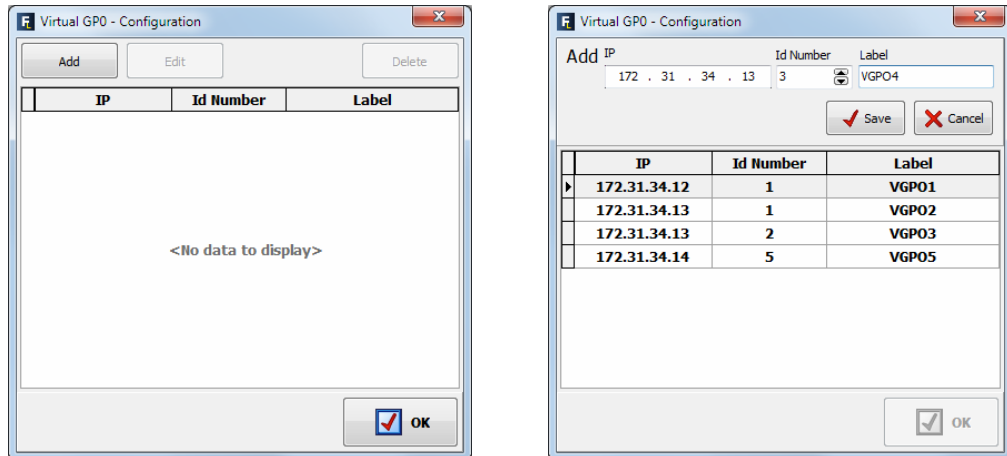

4.2.2. "Mixer Bus Configuration" submenu.

"Mixer Bus Configuration" submenu is accessed, from the drop-down menu "Hardware Configuration", by clicking on the icon:



"Mixer Bus Configuration" submenu allows you to define the configuration of the internal summing buses of the mixer. AEQ FORUM LITE is supplied configured with the following factory default buses:

- **"Program"**: stereo and with working mode defined as "Program".
- **"Audition"**: stereo and with working mode defined as "Audition".
- **"Aux 1"**: stereo and with working mode defined as "Aux 1".
- **"Aux 2"**: stereo and with working mode defined as "Aux 2".
- **"Cue"**: PFL bus, stereo and with working mode defined as "Cue".
- **"Studio"**: output bus toward studio monitors and headphones, stereo and with working mode defined as "Studio".
- **"Control"**: output bus toward control monitors and headphones, stereo and with working mode defined as "Control".
- **"MPX 1"**: mono and with working mode defined as "MPX 1".
- **"MPX 2"**: mono and with working mode defined as "MPX 2".
- **"MPX 3"**: mono and with working mode defined as "MPX 3".
- **"MPX 4"**: mono and with working mode defined as "MPX 4".
- **"MPX 5"**: mono and with working mode defined as "MPX 5".
- **"MPX 6"**: mono and with working mode defined as "MPX 6".
- **"MPX 7"**: mono and with working mode defined as "MPX 7".
- **"MPX 8"**: mono and with working mode defined as "MPX 8".

You can edit the "Label" for each mixer bus. If a mixer bus in factory configured as stereo is reconfigured to mono, the liberated channel will pop up on the configuration screen as available. The opposite would happen if you change the settings for an initially mono bus, "MPX 1" for instance: when you reconfigure it for stereo operation, the next bus line, "MPX 2" in this case, will disappear from the available buses on the configuration screen since this bus will be added to "MPX 1".

You can define up to 32 mono or 16 stereo mixer buses, including the 7 predefined stereo buses and the 8 MPX mono buses as described above. The remainder of mixing buses can be defined as "Internal". An internal bus is simply an additional bus with software user-defined functionality. Its name, "internal" doesn't imply that its signal can't be routed to any physical output that is not assigned to another bus. 2 of those remaining buses could be defined as mono buses with "MPX 9" or "MPX 10" working mode.

IMPORTANT NOTE: The routing toward MPX internal summing buses is saved on console configuration and it will appear in the "Routing Configuration" submenu when the active configuration is read.

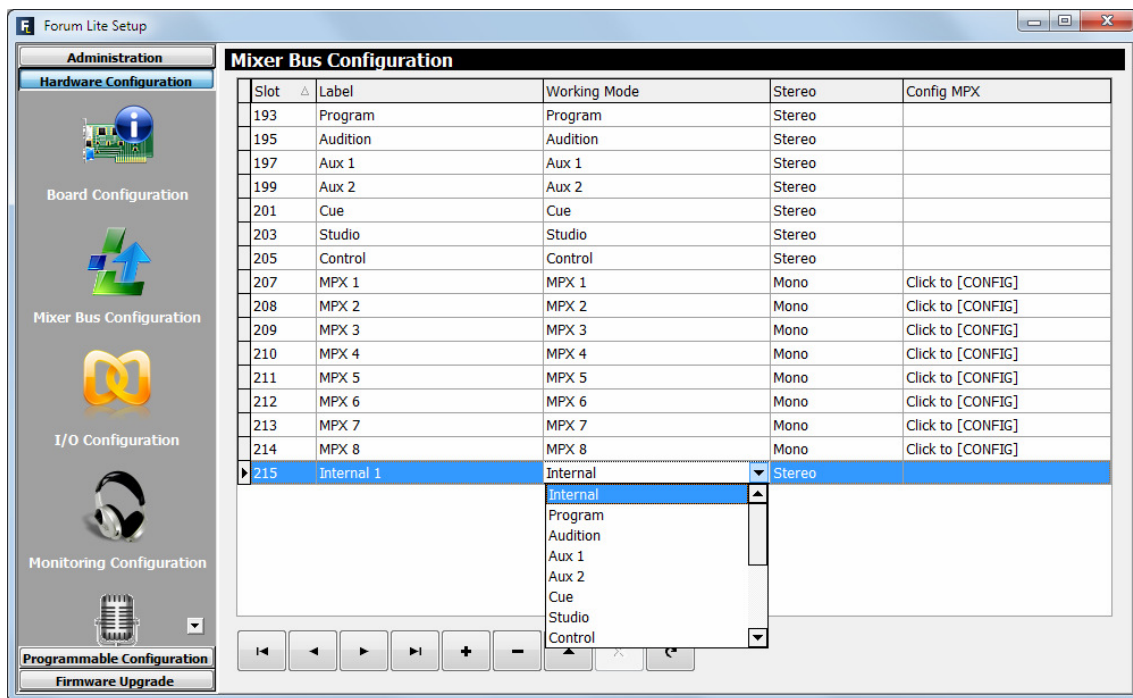

The mixer bus configuration table has the following fields:



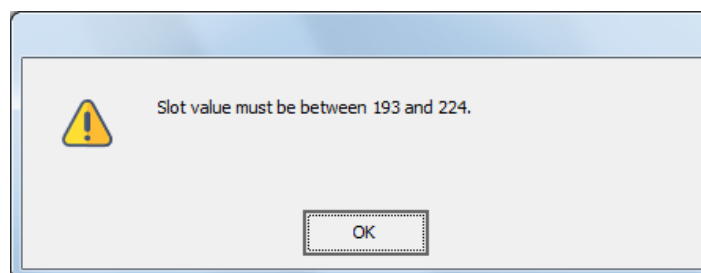





- **"Slot"**: indicates the internal position of this signal in the digital audio bus of the mixer. The 32 available slots are numbered between 193 and 224 both inclusive. A warning message will appear when you try to define a bus above those 32 available slots:



- **"Label"**: name of the bus. Maximum number of characters recommended is 6.
- **"Working Mode"**: is the description provided by the system regarding the functionality of each bus: Program, Audition, Aux 1, Aux 2, Cue, Studio, Control, MPX 1 to 10 or Internal.
- **"Stereo"**: allows you to configure the bus as a mono or stereo one.
- **"Config MPX"**: allows you to configure the working mode of the selected MPX bus as "Multiplex" or "Clean Feed". To access, click on **"Click to [CONFIG]"** and then clicking again on the **"CONFIG"** button that will appear. See sections 4.2.2.1 and 4.3.2.5 of this manual.

By clicking on each column header, the table will be sorted in accordance to this column.

The lower part of the "Mixer Bus Configuration" submenu includes a set of standardized buttons to manage the list of internal buses:

-  Allows you to scroll to the top of the list.
-  Allows you to move to the position immediately above in the list.
-  Allows you to move to the position immediately below in the list.
-  Allows you to scroll to the last position of the list.
-  Allows you to insert a new entry in the list.
-  Allows you to delete the selected entry from the list. Confirmation is requested.
-  Allows you to edit the selected entry.
-  Allows you to reject to the selected entry.
-  Allows you to refresh the information shown in the list.

4.2.2.1. Configuration of MPX buses menu. "Clean Feed" mode.

When you press the "CONFIG" button, that appears after clicking on "Click to [CONFIG]", the following window will appear:

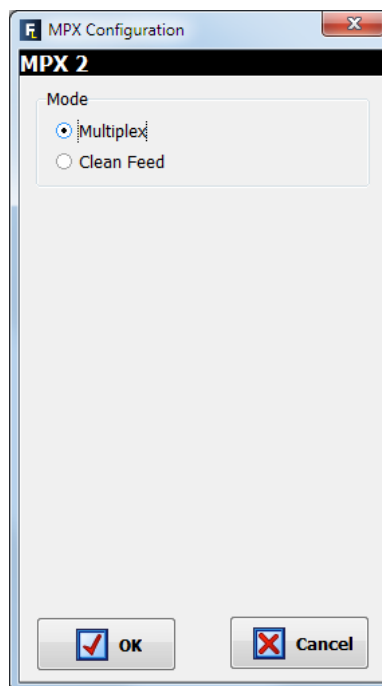

When the selected bus maintains the "Multiplex" option selected (this is the default option), the working mode is the usual for these buses: see section 4.3.2.5 of this manual.

When the "Clean Feed" option is selected, the window will change to:

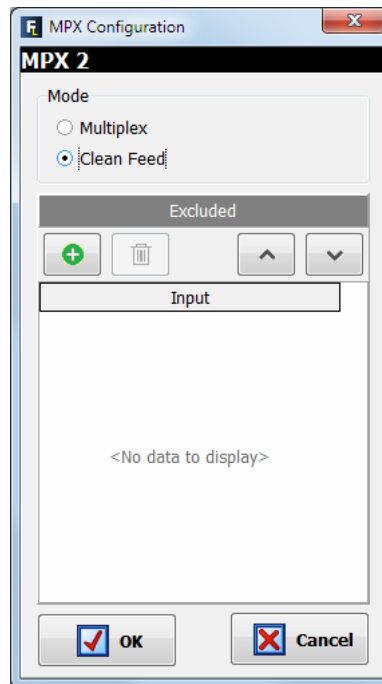

and allows you to configure a special group of multiplex named "Clean Feed", that allows to **automatically** establish a routing of the active signals in a certain moment toward that bus, with no need of explicitly routing.

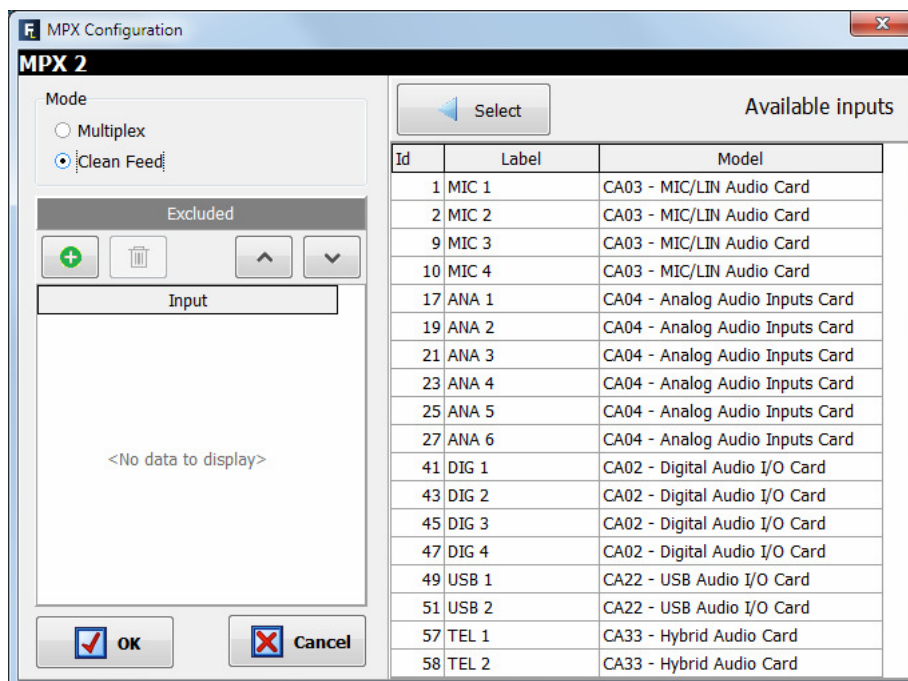

The input signal or signals that will be excluded from that "Clean Feed" group must be added in "Excluded" section. When the button  is pressed a list of all the system available inputs will appear at the right:

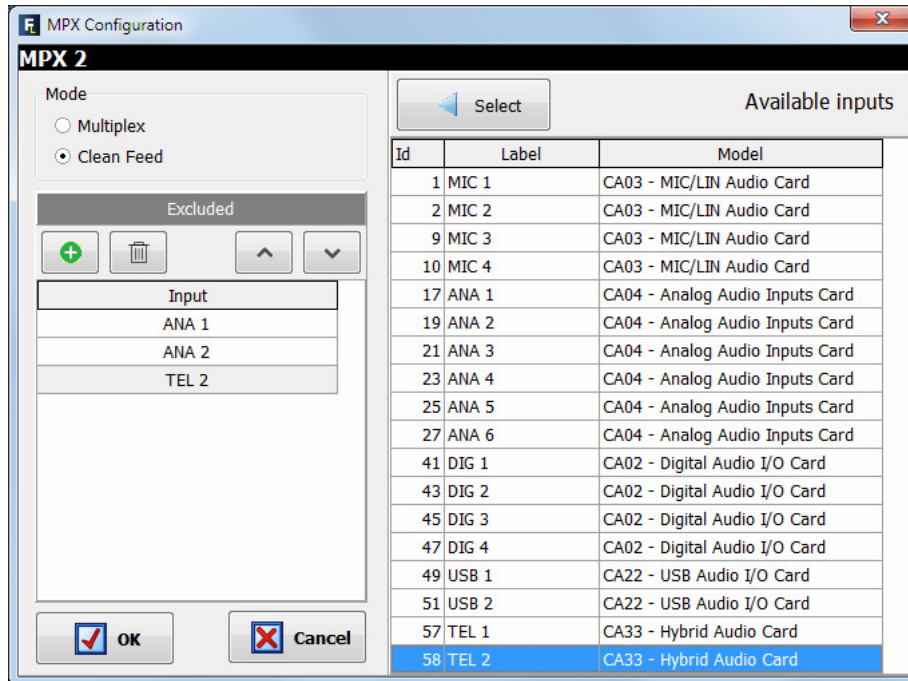

In order to exclude an input from the group just select it in the list and press the "Select" button.



In the example, the "ANA 1", "ANA 2" and "TEL 2" inputs have been excluded from the group associated with "MPX 2" bus. The **order** is **very important** in this kind of "Clean Feed" groups because the first selected input will established the operative **priority** in that group in each moment.

You can eliminate an input from the "Excluded" section by means of the button  and you can modify the order of the selected inputs (when there is more than one, obviously) by means of the buttons  and .

When you press "OK" creation of the group is confirmed and the window is closed. If you open it again, by pressing the "CONFIG" button, you can check the excluded signals and edit this selection (add/eliminate inputs or modify the order):

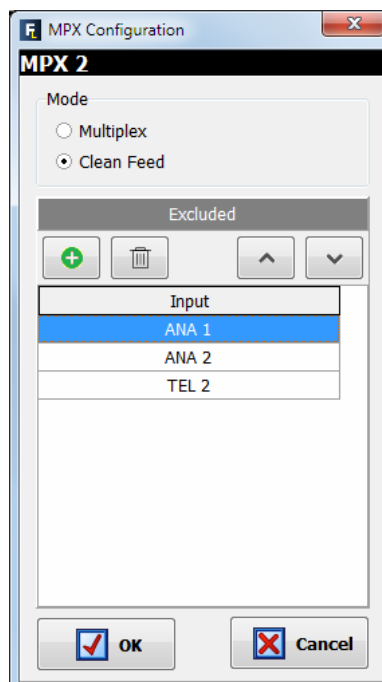

Once the group is defined ("MPX 2" in the example) the operation is as follows:

- Priority 5:** Let's suppose that the starting point is that none of the routing keys ("PROGRAM", "AUDITION", "AUX 1" and "AUX 2") of the inputs in control surface is activated.
 All the inputs in control surface that are active in a certain moment (by pressing the "ON" key of the channel) will send signal to the "MPX 2" bus, except the ones that appears in "Excluded" section ("ANA 1", "ANA 2" and "TEL 2" in the example).
- Priority 4:** If we activate now in "ANA 1" channel (the one that appears in first place in "Excluded" section) the "**AUX 2**" routing key (whether the channel is active or not), this will be the new operative priority of the group, so only the active channels ("ON" key pressed) with also the "AUX 2" routing key activated (and NOT the other routing keys) will send now signal to the "MPX 2" bus.
- Priority 3:** If we activate now in "ANA 1" channel the "**AUX 1**" routing key (whether the channel and the "AUX 2" key are active or not), this will be the new operative priority of the group, so only the active channels ("ON" key pressed) with also the "AUX 1" routing key activated (and NOT the "PROGRAM" and "AUDITION" keys) will send now signal to the "MPX 2" bus.
- Priority 2:** If we activate now in "ANA 1" channel the "**AUDITION**" routing key (whether the channel and the "AUX 1" and "AUX 2" keys are active or not), this will be the new operative priority of the group, so only the active channels ("ON" key pressed) with also the "AUDITION" routing key activated (and NOT the "PROGRAM" key) will send now signal to the "MPX 2" bus.
- Priority 1:** If we activate now in "ANA 1" channel the "**PROGRAM**" routing key (whether the channel and the other routing keys are active or not), this will become the new operative priority: only the active channels ("ON" key pressed) with also the "PROGRAM" key activated will send signal to "MPX 2" (these channels may have the other routing keys activated or not, it doesn't matter).

As seen, the routing of "ANA 1" input defines the operative priority and therefore the inputs that will send signal to "MPX 2" group in a certain moment, being the sending to "PROGRAM" the higher priority (1) and all the sending deactivated the lower priority (5).

For instance, when the configuration of channels activation and routing in control surface in a certain moment is as follows:



In this case, the "ANA 1" signal defines an operative **priority 1** because the "PROGRAM" routing key is activated (it doesn't matter that the "AUDITION" key is also activated and the channel is not active). "ANA 1", "ANA 2" and "TEL 2" signals will not be sent to "MPX 2" bus because they are excluded from the group.

This way, "MIC 1", "ANA 5" and "TEL 1" signals will be sent to "MPX 2" because these channels are active and their "PROGRAM" routing keys are activated. However, "MIC 2", "MIC 4" and "ANA 4" will not be sent to "MPX 2" because they are active but the "PROGRAM" routing key is not activated. Finally, "MIC 3", "ANA 3" and "ANA 6" signals will not be sent to "MPX 2" because these channels are not active.

If we deactivate now the "PROGRAM" key of "ANA 1" we change to **priority 2** because the sending to "AUDITION" is still activated. This way, only "MIC 4" signal will be sent now to "MPX 2" because it's the only active channel with the "AUDITION" key activated and the "PROGRAM" key deactivated ("ANA 2" has also the same situation but this channel is excluded from the group).

Finally, if we deactivate now the "AUDITION" key of "ANA 1" we change to **priority 5**. This way, only "MIC 2" signal will be sent to "MPX 2" because it's the only active channel with no routing keys activated.

In next example, in addition to that "MPX 2" group, a second group, "MPX 3", is created excluding the "MIC 1" input from it:

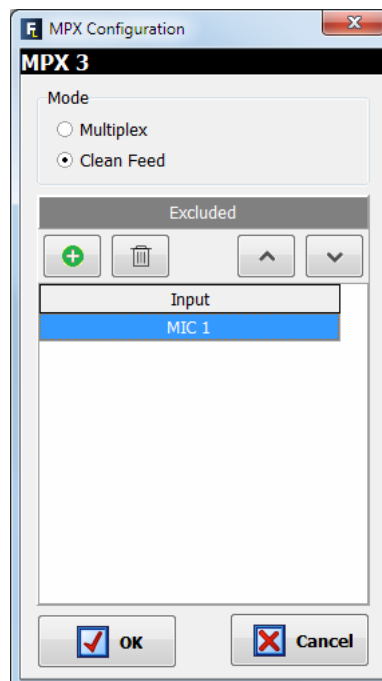

Supposing the configuration of channels activation and routing of the previous image, the "MIC 1" signal defines also in this case an operative **priority 1** for "MPX 3" group because the "PROGRAM" routing key is activated (it doesn't matter that the "AUDITION" and "AUX 2" keys are also activated). This signal will not be sent to "MPX 3" bus because it's excluded from this group.

This way, "ANA 5" and "TEL 1" signals will be sent to "MPX 3" because both channels are active and their "PROGRAM" routing keys are activated. However, "MIC 2", "MIC 4", "ANA 2" and "ANA 4" channels will not be sent to "MPX 3" because they are active but the "PROGRAM" routing key is not activated, and neither "ANA 1" channel because the "PROGRAM" key is activated but the channel is not active. Finally, "MIC 3", "ANA 3", "ANA 6" and "TEL 2" signals will not be sent to "MPX 3" because these channels are not active.

If we deactivate now the "PROGRAM" key of **"MIC 1"** we change to **priority 2** because the sending to **"AUDITION"** is still activated. This way, now "MIC 4" and "ANA 2" signals will be sent now to "MPX 3" because these are the only active channels with the "AUDITION" key activated and the "PROGRAM" key deactivated.

Then, if we deactivate now the "AUDITION" key of **"MIC 1"** we change to **priority 4** because the sending to **"AUX 2"** is still activated. This way, now only "ANA 4" signal will be sent to "MPX 3" because it's the only active channel with just the "AUX 2" key activated.

Finally, if we deactivate now the "AUX 2" key of **"MIC 1"** we change to **priority 5**. This way, only "MIC 2" signal will be sent to "MPX 3" because it's the only active channel with no routing keys activated.

NOTE: If you define a "Multiplex" programmable key and you assign to that key an MPX bus configured as "Clean Feed", when you press and keep pressed the key, the "SELECT" key of the channels that are sending signal toward that bus will turn on. As previously mentioned, that sending is **automatic** because "Clean Feed" mode is used, while the routing is usually activated/deactivated manually when "Multiplex" mode is used. Although it's not the usual operation, you can temporarily deactivate the sending of a certain channel toward the MPX bus by keeping pressed the programmable key and pressing the "SELECT" key of the channel; this sending will be automatically recovered when you deactivate and reactivate the channel by means of the "ON" key (o when you deactivate and reactivate the routing key) or manually by pressing again the programmable key and then the "SELECT" key.

4.2.3. "I/O Configuration" submenu.

"I/O Configuration" submenu is accessed, from the drop-down menu "Hardware Configuration", by clicking on the icon:



This submenu allows you to configure the logical audio channels from the physical audio inputs and outputs and as previously defined in the "Board Configuration" submenu.

There are two distinct parts in this submenu; upper part of the screen is dedicated to the input channels configuration and the lower part of the screen is for the output channels configuration. In both parts of the screen the tables have the following fields:

- **"Id"**: indicates the equipment internal position of the signal.
- **"Label"**: alphanumeric name of the channel. Maximum number of characters recommended is 6. This is the name that appears in all displays and menus of the AEQ FORUM LITE control surface.
- **"Model"**: type of the physical inputs/outputs present in the rear panel of the unit. This field will be populated automatically once the "Board Configuration" has been accomplished (see section 4.2.1 of this manual).
- **"Config"**: access to advanced settings menu for the selected logical channel. To access, click on **"Click to [CONFIG]"** and then clicking again on the **"CONFIG"** button that will appear.

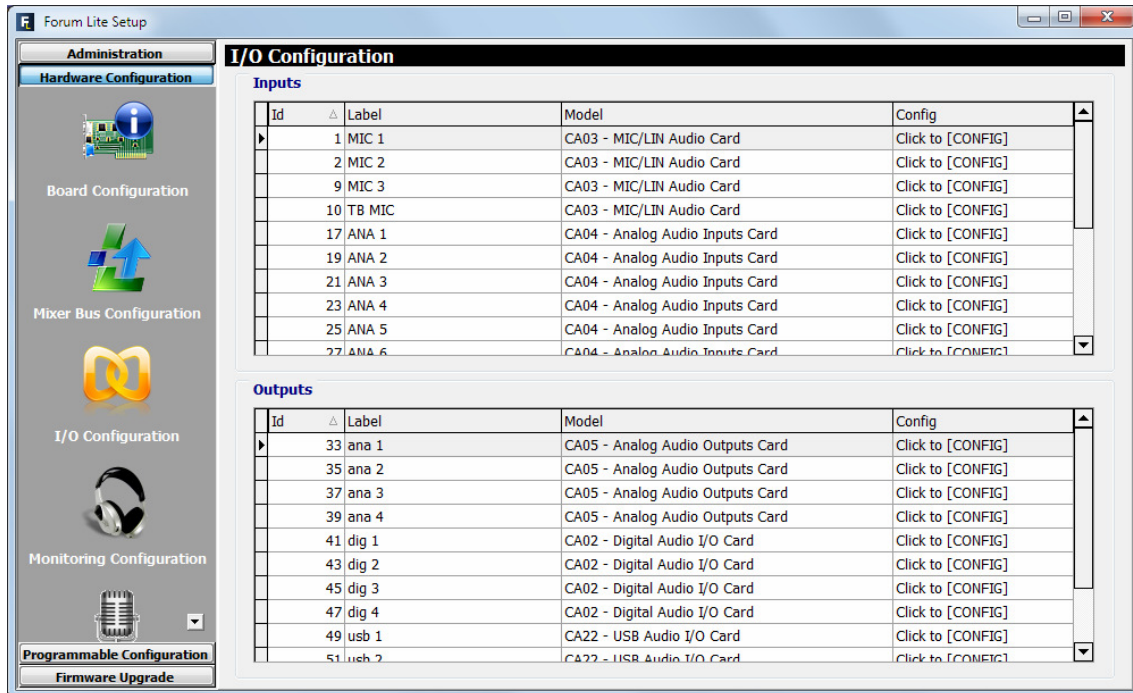

4.2.3.1. Advanced configuration of input channels menu.

Even if all configuration options and possibilities are explained hereunder, it should be taken into account the on-screen options may vary depending on the inputs/outputs module that the logical audio channel has been configured for:

- **Headers:** indicates the type and position of the virtual module that is configured at that moment.
 - **"FRzz Input configuration"** means that we are setting the input of a FR"zz" type virtual card.
 - **"INPUT HW:xx.0y"** means that we are setting the input "y" of the virtual card located in the position xx.
- **"Label":** alphanumeric name of the channel. Maximum number of characters recommended is 6. This is the name that appears on all displays and menus of the AEQ FORUM LITE control surface.
- **"Fader Start":** allows you to select a physical or virtual GPO (from the list defined in section 4.2.1.1) to perform the Fader-start function for this channel. You can not associate the same GPO to several channels. "None" indicates there is no Fader-start function associated with that channel.

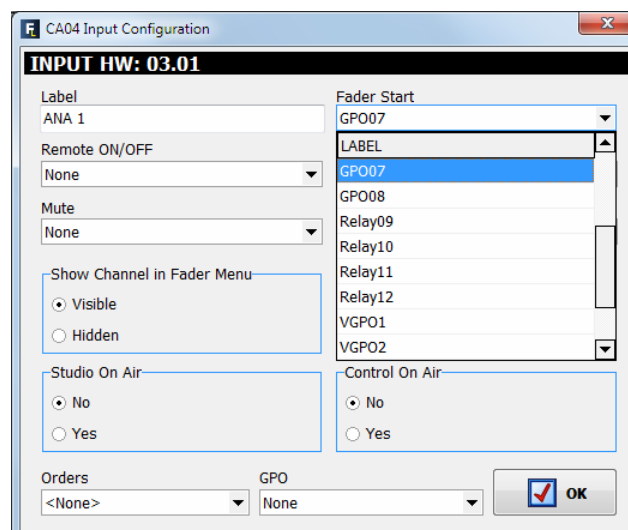

- **"Remote ON/OFF"**: allows you to select a physical or virtual GPI (from the list defined in section 4.2.1.1) to perform the remote start function for this channel ("CHANNEL ON/OFF" keys on control surface: see paragraph 2.1.1.8 of this manual). "None" indicates there is no Remote ON/OFF function associated with that channel.

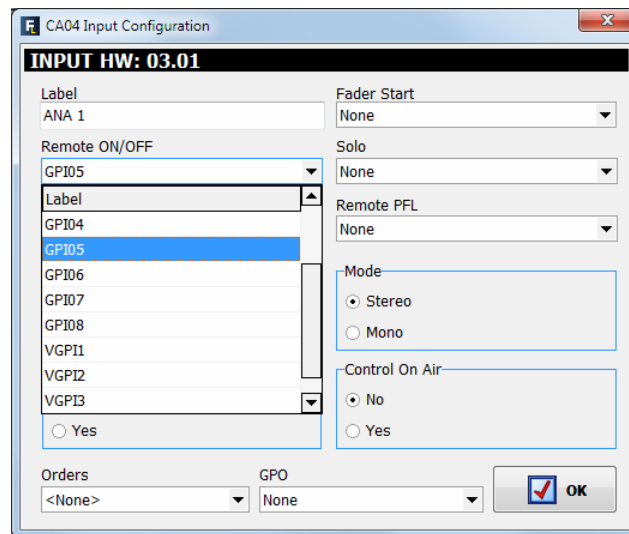

- **"Solo"**: allows you to select a physical or virtual GPI (from the list defined in section 4.2.1.1) to remotely cut the audio of all the inputs except the one that has been associated with the SOLO function. This is useful when for example multiple microphones are used for the invited guests and the moderator needs to cut all the mics except his own. You can not associate the same GPI to several channels. "None" indicates there is no SOLO function associated with that channel.

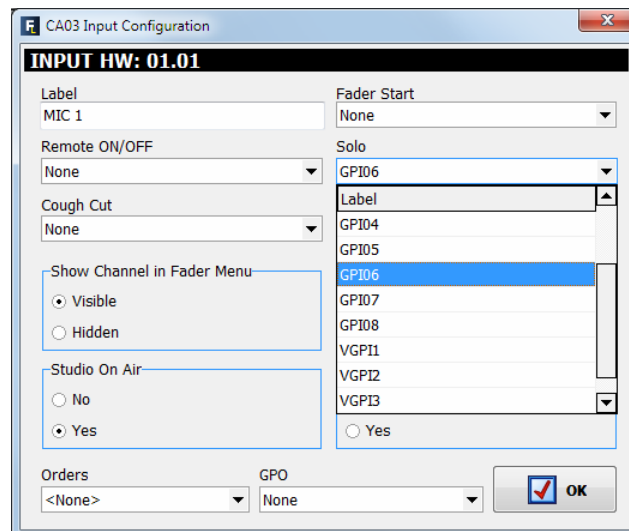

- **"Cough Cut"**: allows you to select a physical GPI (from a wired STUDIOBOX or SCR-03 for instance) or a virtual GPI (from a NETBOX 4 MH for instance), from the list defined in section 4.2.1.1, to perform the cough-cut function for this channel. This option is only available for **microphone** channels. "None" indicates there is no cough-cut function associated with that channel.

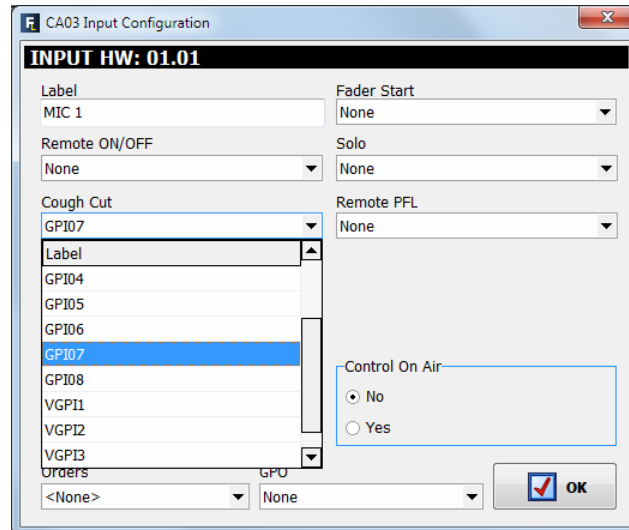

- **"Remote PFL"**: allows you to select a physical GPI (from a wired STUDIOBOX or SCR-03 for instance) or a virtual GPI (from a NETBOX 4 MH for instance), from the list defined in section 4.2.1.1, associated with the sending of the input channel to the CUE output. You can not associate the same GPI to several channels. "None" indicates there is no Remote PFL function associated with that channel.
- **"Mute"**: allows you to select a physical GPI (from a wired push button for instance) or a virtual GPI (from a NETBOX 4 MH, 8 AD or 32 AD for instance), from the list defined in section 4.2.1.1, associated with the function to mute the channel selected upon receiving a remote command. This option is **not** available for **microphone** channels. "None" indicates there is no Mute function associated with that channel.

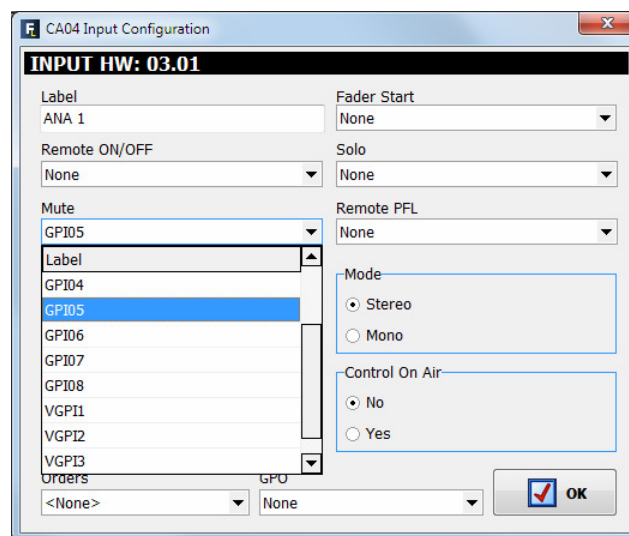

- **"Show Channel in Fader Menu"**: allows you to select whether the selected input channel can be associated ("Visible") or not ("Hidden") to a channel from AEQ FORUM LITE control surface through "FADER" menu (see section 3.4.3.1.3.1). An example of a typically "Hidden" signal would be the time TOPS.
- **"Mode"**: allows you to define whether the selected input channel is Mono or Stereo. By default, all the input channels (except the microphone inputs and the optional internal telephone hybrid ones) of AEQ FORUM LITE are defined as Stereo. If any channel is re-configured to Mono it will result in an incremented number of the listed available input channels: one Stereo Channel is converted into two Mono channels. This option is **not** available for **microphone** channels and neither for optional internal **telephone hybrid** channels.

- **"Studio On Air"**: associates the activation of Channel ON/OFF key of this channel with the triggering of a GPO for the "ON-AIR" lights of the Studio room (see section 4.2.4.1 of this manual). It also associates the studio monitors muting (or attenuation: see section 4.3.2.9 of this manual). Typically you would associate this function to microphone channels.
- **"Control On Air"**: associates the activation of Channel ON/OFF key of this channel with the triggering of a GPO for the "ON-AIR" lights of the Control room (see section 4.2.4.1 of this manual). It also associates the muting of the control monitors and the CUE bus. Typically you would associate this function to auto-control microphone channel.

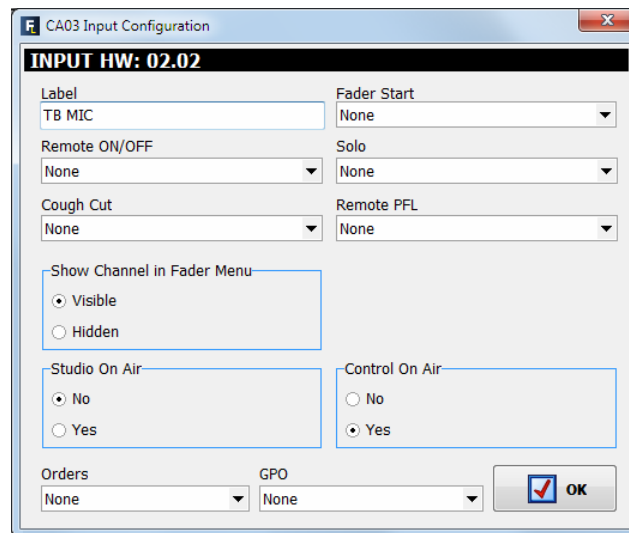

- **"Orders"**: associates an output channel to the selected input channel where you'll send the orders microphone when you press and keep pressed the lower activation key of the control surface channel that input signal is assigned to. In order to work this way, the "Orders" ON/OFF mode must be activated in the corresponding configuration memory or snapshot (for more information, see section 4.3.5 of this manual).

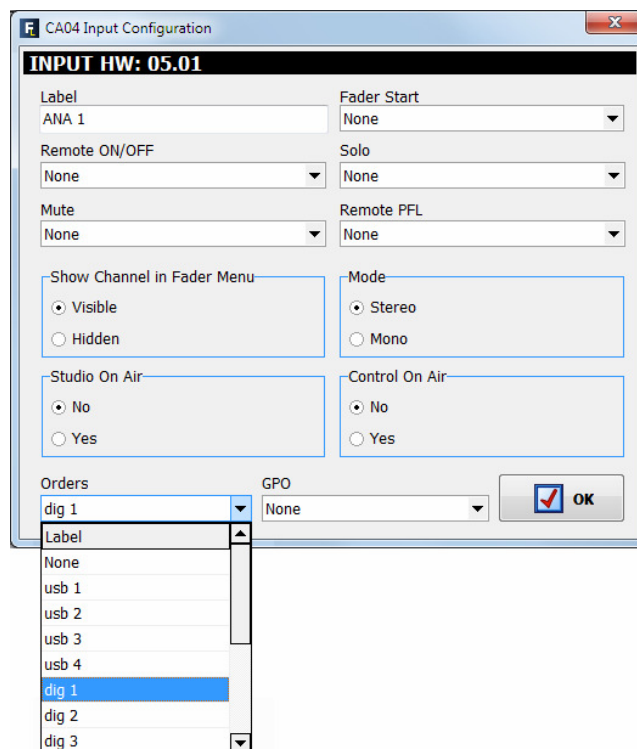

- **"GPO"**: associates a physical or virtual GPO output to the selected input channel that will be activated when you press and keep pressed the lower activation key of the control surface channel that input signal is assigned to (the GPO will be deactivated when you release the key). In order to work this way, the "GPO" ON/OFF mode must be activated in the corresponding configuration memory or snapshot (for more information, see section 4.3.5 of this manual). You can not associate the same GPO to several channels.

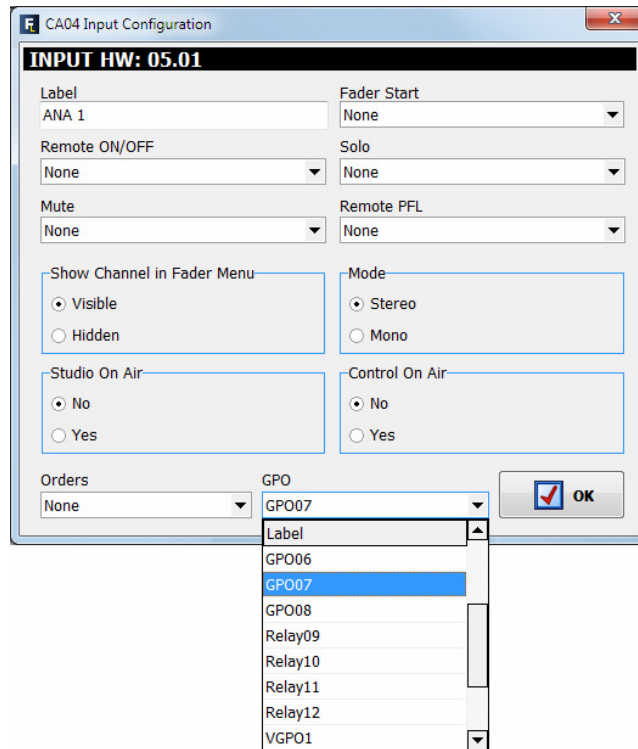

4.2.3.2. Advanced configuration of output channels menu.

Even if all configuration options and possibilities are explained hereunder, it should be taken into account that the on-screen options may vary depending on the inputs/outputs module that the logical audio channel has been configured for.

- **Header**: Informative field that indicates type and position of the module that is configured at that moment.
 - **"OUTPUT HW:xx.0y"** means that we are setting the output "y" of the virtual card located in slot xx.
- **"Label"**: alphanumeric name of the channel. Maximum number of characters recommended is 6. This is the name that appears on all displays and menus of the AEQ FORUM LITE control surface.
- **"Default Routing"**: allows you to configure the signal routed by default to that output channel. You can select any input channel ("Inputs" in "Type" column) or any of the internal summing buses ("Mixer" in "Type" column; see section 4.2.2 of this manual).
- **"Mode"**: allows you to configure the logical output channel as Mono or Stereo. By default, all the outputs channels of AEQ FORUM LITE are defined as Stereo. If any channel is re-configured to Mono it will result in an incremented number of the listed available output channels: one Stereo Channel is converted into two Mono channels. This option is **not** available for optional internal **telephone hybrid** channels.

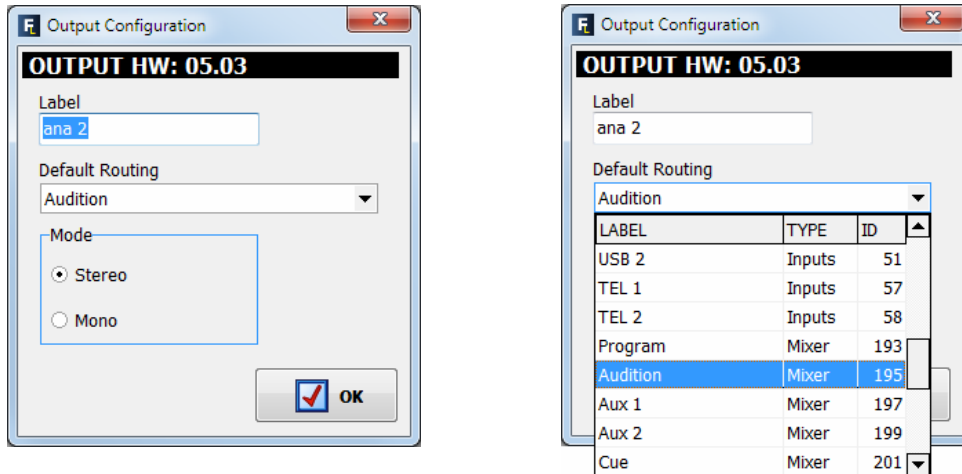

4.2.4. "Monitoring Configuration" submenu.

"Monitoring Configuration" submenu is accessed, from the drop-down menu "Hardware Configuration", by clicking on the icon:



"Monitoring Configuration" submenu allows you to define the operation of the Control and Monitoring sections associated with the control room and the studio room. Please refer to sections 2.1.2.4 and 2.1.2.5 of this manual.



There are two distinct parts in this submenu: the upper part is dedicated to the configuration of the Studio Room section and the lower to the Control Room section.

An example of signalling connection appears in appendix A of this manual.

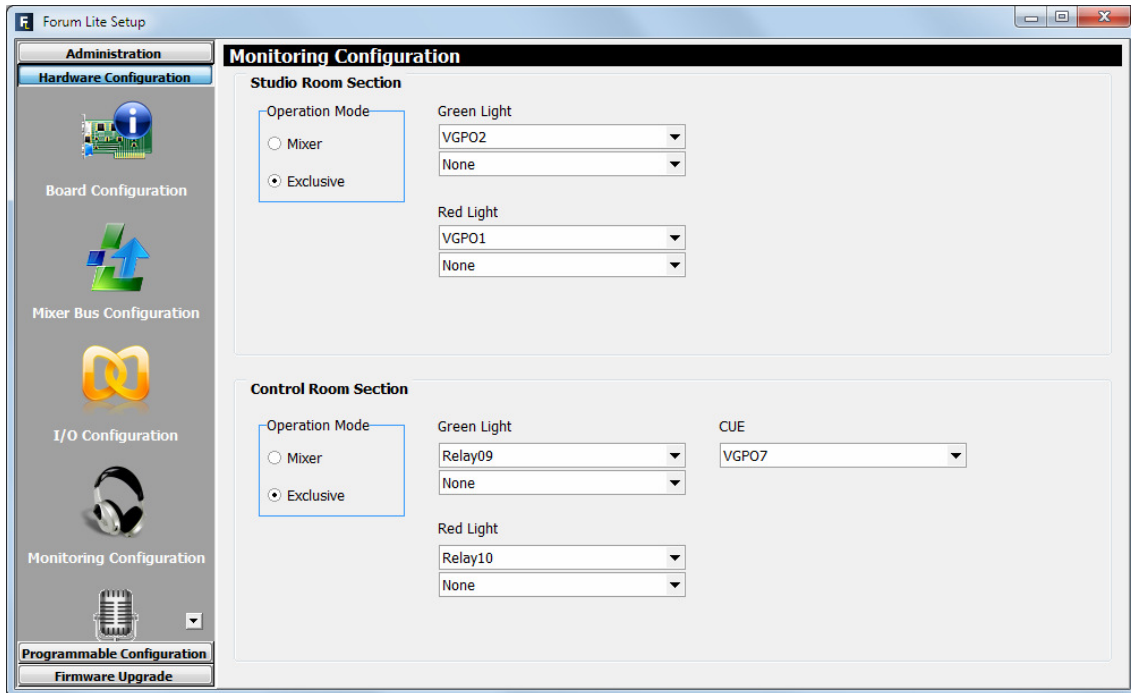

4.2.4.1. "Studio Room Section".

This section of "Monitoring Configuration" submenu lets you choose how the four keys under the display of the **Studio Room** Control and Monitoring section shall work, either in "**Mixer**" or "**Exclusive**". If the option "Mixer" is selected, the output bus associated with "Studio" monitor and headphones will act as a summing bus and therefore may be more than one of the four keys simultaneously activated, thus mixing the signals corresponding to each of the four keys on the studio monitor and headphones. On the other hand, in the "Exclusive" mode, this output bus will not act as a summing bus and therefore may not be more than one key activated at any given time (this effectively means that by pressing any of the four keys, the previously activated one will be disconnected from the summing bus and replaced by the new selection).

In this section you can also assign the **GPO** outputs associated with Studio "OFF AIR" green light (indicates that there are no sources, typically microphones, activated in the studio room) and "ON AIR" red light (indicates that there are sources, typically microphones, activated in the studio room). It's possible to assign **up to 2 GPOs** to each option. You can choose between the opto-coupled GPOs (1 to 8), the virtual GPOs or the contact relay GPOs (9 to 12): these last ones are recommended, except for long distances and shared studios where using virtual GPOs could be a better option. See section 2.2.2.1 of this manual. When a GPO or relay already used is selected, a warning message will appear and a different one must be selected.

The upper image shows an example where the Studio Room lights are managed through virtual GPOs, that may be sent to a NETBOX 4 MH for instance.

4.2.4.2. "Control Room Section".

This section of "Monitoring Configuration" submenu lets you choose how the four keys under the display of the **Control Room** Control and Monitoring section shall work, either in "**Mixer**" or "**Exclusive**". If the option "Mixer" is selected, the output bus associated with "Control" monitor and headphones will act as a summing bus and therefore may be more than one of the four keys simultaneously activated, thus mixing the signals corresponding to each of the four keys on the studio monitor and headphones. On the other hand, in the "Exclusive" mode, this output bus will not act as a summing bus and therefore may not be more than one key activated at any given time (this effectively means that by pressing any of the four keys, the previously activated one will be disconnected from the summing bus and replaced by the new selection).

In this section you can also assign the **GPO** outputs associated with Control "OFF AIR" green light (indicates that there are no sources, typically microphones, activated in the control room) and "ON AIR" red light (indicates that there are sources, typically microphones, activated in the control room). It's possible to assign **up to 2 GPOs** to each option. You can choose between the opto-coupled GPO's (1 to 8), the virtual GPOs or the contact relay GPO's (9 to 12): these last ones are recommended. See section 2.2.2.1 of this manual.

Finally, the "**CUE**" option allows you to select a **GPO** that will be activated when one or more channels are sent to CUE and will remain activated until the last sending to CUE is deactivated or the "CUE RESET" key is pressed.

When a GPO or relay already used is selected, a warning message will appear and a different one must be selected.

The previous image shows an example where the Control Room lights are managed through 2 console relays and the activation of any sending to CUE activates a virtual GPO.

4.2.5. "Visual Radio" submenu.

"Visual Radio" submenu is accessed, from the drop-down menu "Hardware Configuration", by clicking on the icon:

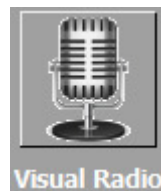

"Visual Radio" functionality allows you to send vumeters of any of the inputs of the unit to a certain IP address. In order to activate this function you must purchase a user license (see section 4.1.1 of this manual).

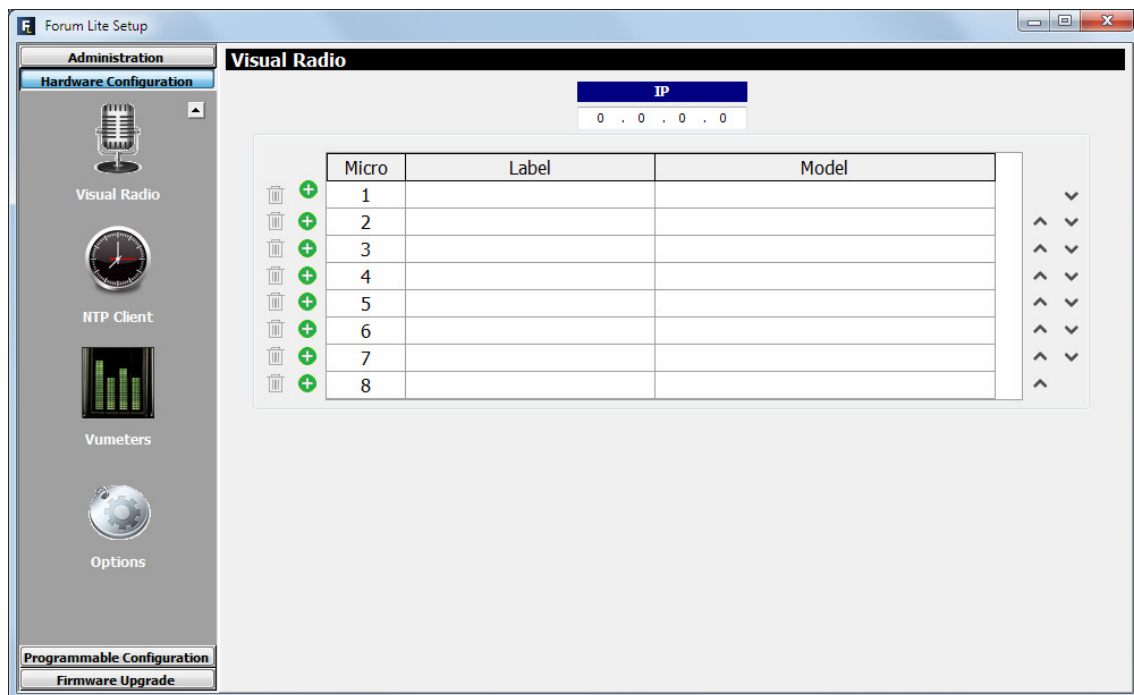

In this submenu first you must configure the destination IP address (it must be in the same subnet of the IP address associated with "LAN" Ethernet port) and then select the input or inputs of the unit (up to a maximum of 8) whose vumeters will be sent to that IP address.

When you press the button a list of the available logical inputs of the system will be displayed at the lower part of the screen:

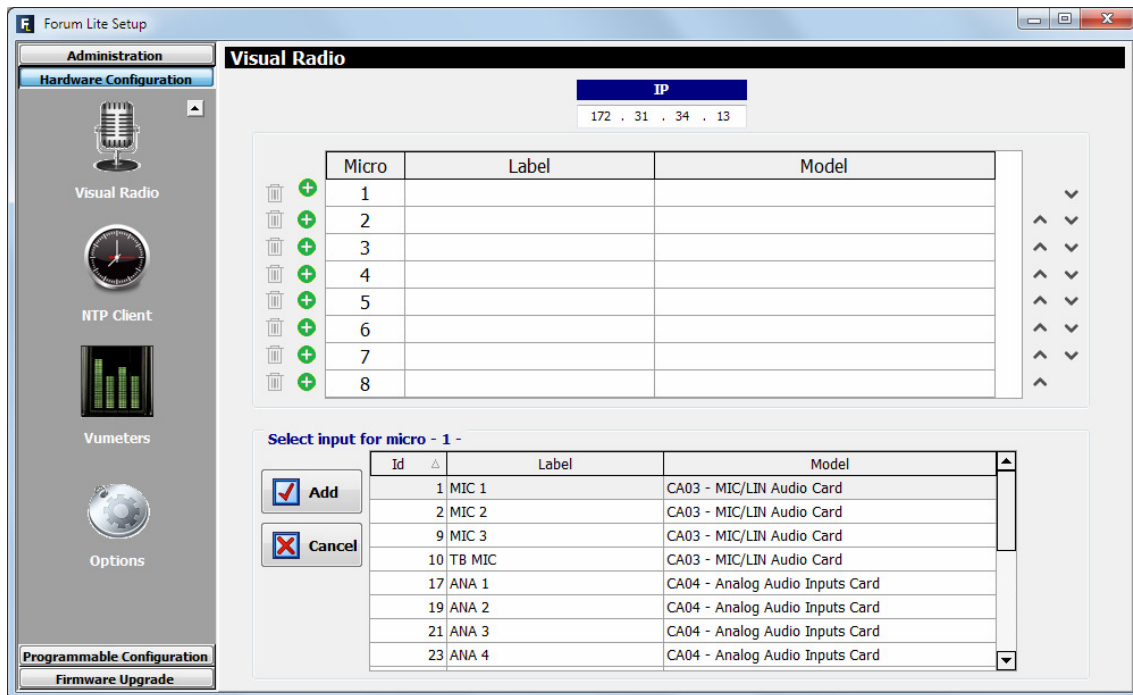

After selecting the desired input and pressing the "Add" button, this input will appear in the list of signals associated with the "Visual Radio" functionality.

The following example shows that the destination IP address is 172.31.34.13 and that the first analog input, the mics 1 and 2 and the first digital input will be sent to that address, with the "Micro" fields from 1 to 4 respectively associated:

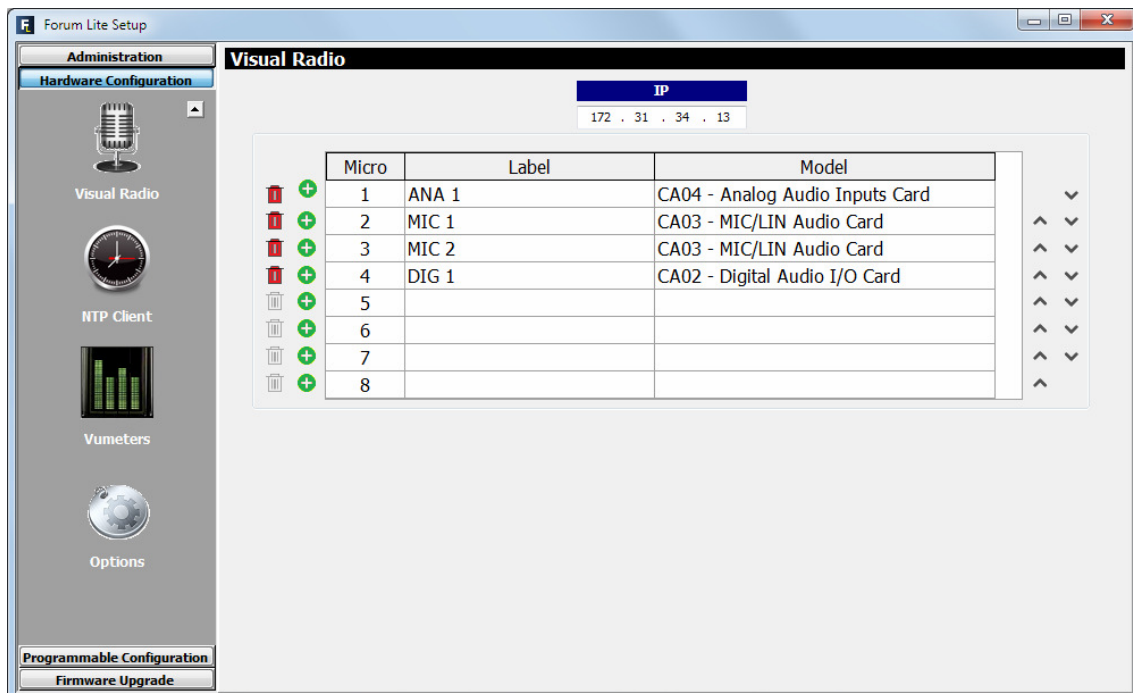

The button allows you to eliminate any of the configured inputs.

The buttons allows you to change the order of the listed signals.

4.2.6. "NTP Client Configuration" submenu.

"NTP Client Configuration" submenu is accessed, from the drop-down menu "Hardware Configuration", by clicking on the icon:



"NTP Client Configuration" submenu allows you to enable synchronization of the date and time of the system using standard Ethernet NTP protocol, with the local AEQ FORUM LITE clock slaved to the remote (NTP) signal.

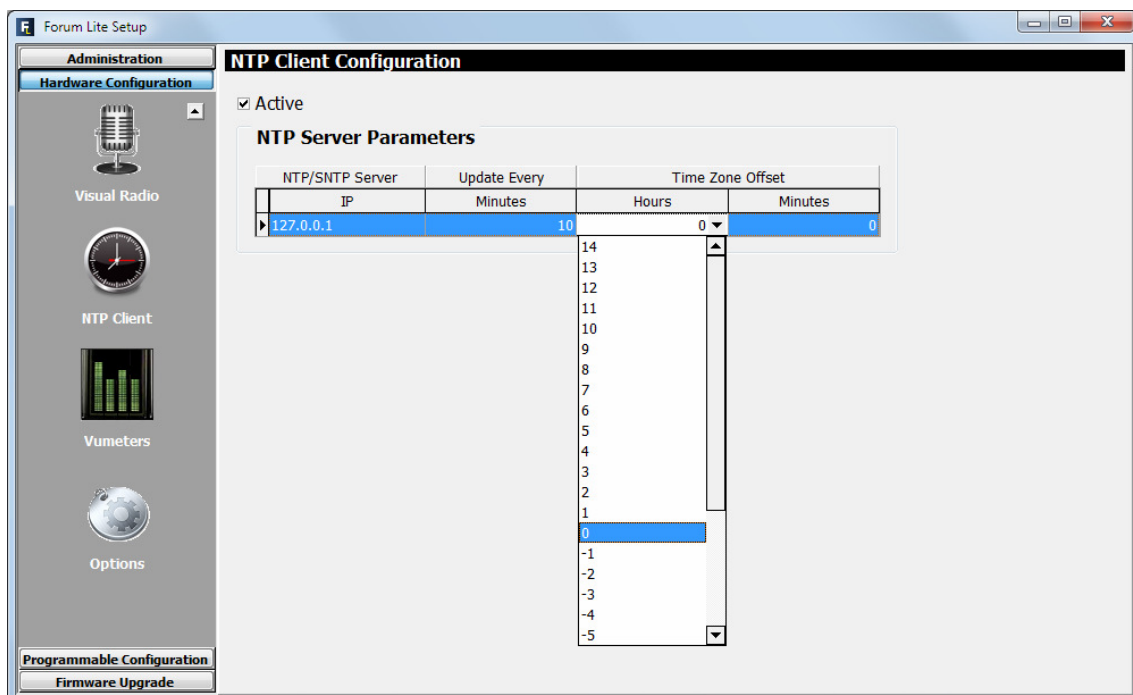

The on-screen options are the following ones (the last 4 ones only appear when the first option is active):

- **"Active"**: allows you to activate or not this option. By default, it's deactivated.
- **"NTP/SNTP Server - IP"**: IP address of the server with the remote master clock.
- **"Update Every - Minutes"**: refresh period, the frequency with which AEQ FORUM LITE will contact the remote NTP time server to confirm that there are no deviations. The default value is set to 10 minutes.
- **"Time Zone Offset - Hours"**: allows you to compensate for the difference in time zone(s) between the location of the console and the time zone where the remote NTP clock is located. You can configure this field between -14 and 14 hours.
- **"Time Zone Offset - Minutes"**: allows you to compensate for the difference in time zone(s) between the location of the console and the time zone where the remote NTP clock is located. You can configure this field as 0, 15, 30 or 45 minutes.

4.2.7. "Vumeters" submenu.

"Vumeters" submenu is accessed, from the drop-down menu "Hardware Configuration", by clicking on the icon:

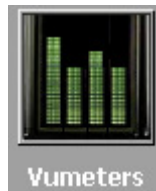

"Vumeters" submenu allows you to configure the vumeters transmission mode and the peakmeter.

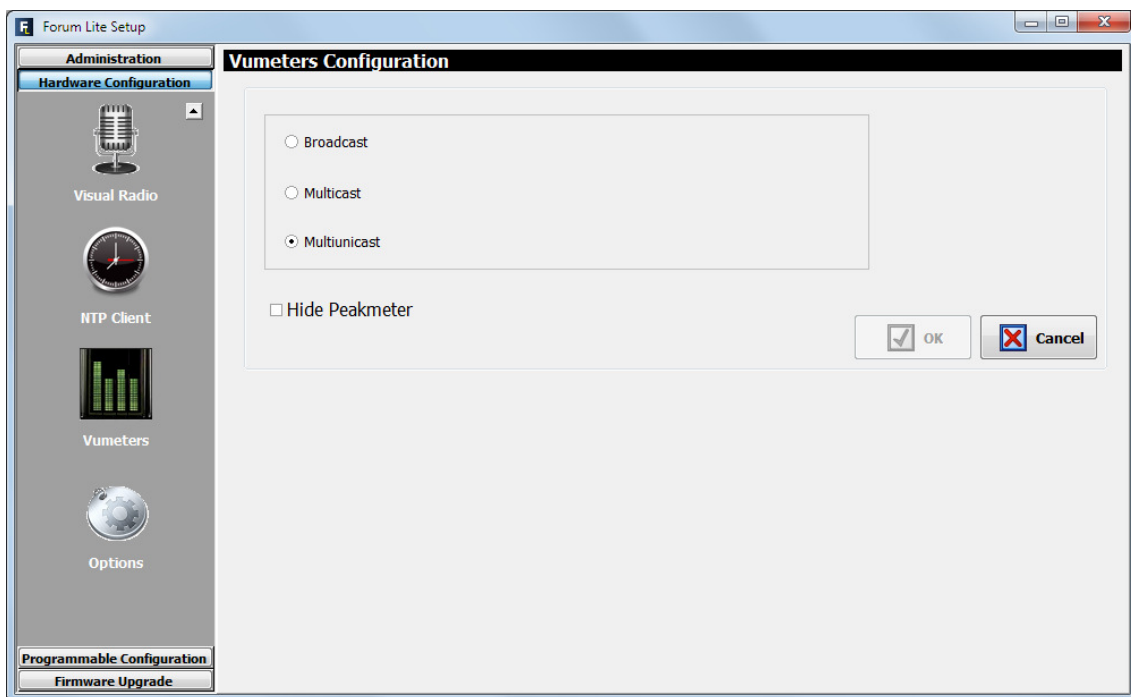

The on-screen options are:

- **"Broadcast"**: allows you to activate the Broadcast vumeters transmission. Vumeters are sent to all the LAN clients but this option would not work for a WAN because the option for distributing Broadcast frames usually is not enabled in routers.
- **"Multicast"**: allows you to activate the Multicast vumeters transmission. When this option is selected a sending group must be configured: Multicast groups are between 224.x.x.x and 239.x.x.x. In this case vumeters are distributed to all the clients subscribed to that Multicast group; routers use to allow Multicast frames, so this option is appropriate for a WAN.

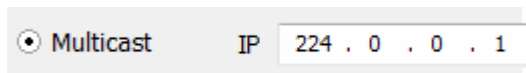

- **"Multiunicast"**: allows you to activate the Multiunicast vumeters transmission (this is the default configuration). In case that Multicast frames are not allowed in a WAN, this option should be used: the console sends UDP unicast frames to each one of the connected clients.

In addition, the **"Hide Peakmeter"** checkbox allows you to activate or not this option (by default, it's deactivated). When activated, the peakmeter of the vumeters is hidden.

4.2.8. "Options" submenu.

"Options" submenu is accessed, from the drop-down menu "Hardware Configuration", by clicking on the icon:

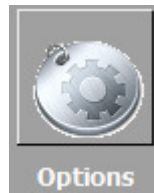

"Options" submenu shows 4 options:

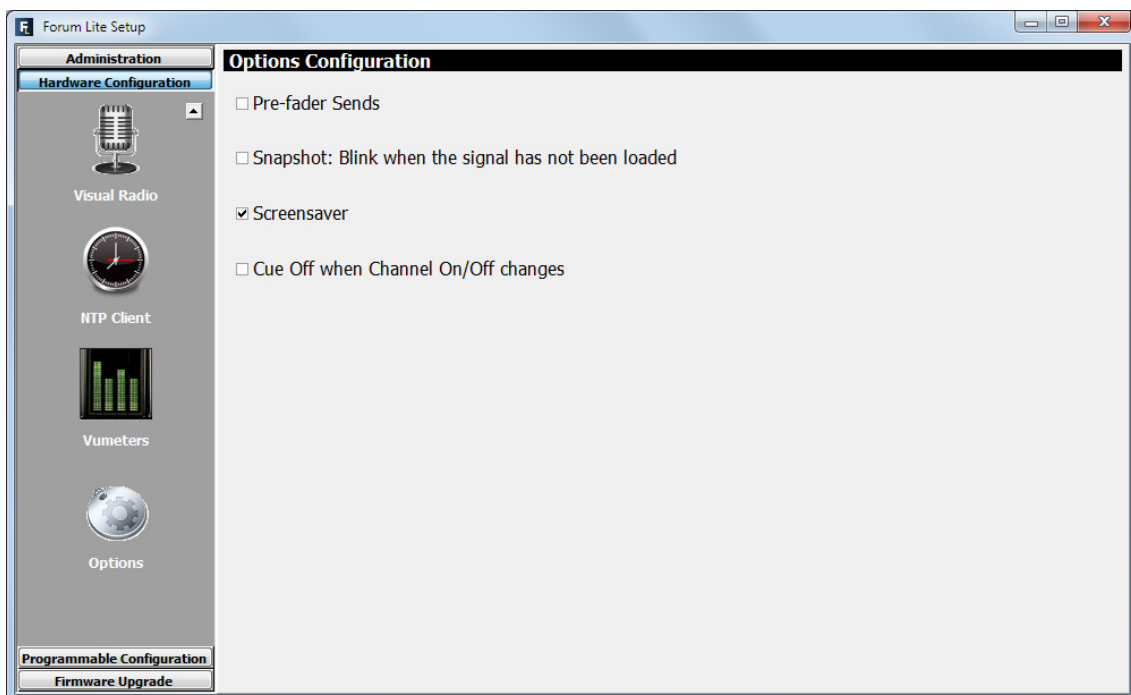

- **"Pre-fader Sends"** checkbox allows you to activate or not this option (by default, it's deactivated), that allows you to configure the operation mode of the sends to the summing buses. When activated, from the "ROUTE" menu (in the main display of the Control and Monitoring section of the control surface) it's possible to unlink the sends of a certain input to the desired system summing buses from the fader, so that the variation of the channel fader doesn't affect those sends level. See section **3.4.3.1.3.3. "ROUTE" menu**.
- **"Snapshot: Blink when the signal has not been loaded"** checkbox allows you to activate or not this option (by default, it's deactivated). As indicated in section 3.3, when a new configuration memory or snapshot is loaded, the audio of the activated channel or channels (ON AIR) will not be interrupted (and the associated routing will remain) provided that in the new memory the activated channel or channels are placed in the same fader positions. When the option "Snapshot: Blink when the signal has not been loaded" is also activated, the upper activation key (the one associated with ON function) of that activated channel or channels will start blinking to indicate that they keep the previous configuration.
- **"Screensaver"** checkbox allows you to activate or not this option (by default, it's activated). When activated, a lateral scroll of the information that appears in channel and monitoring sections displays starts when the control surface enters low lighting mode (after remaining about 5 minutes without being used).

- **"Cue Off when Channel On/Off changes"** checkbox allows you to activate or not this option (by default, it's deactivated). When activated, if there's a signal sent to CUE, it's deactivated when there is a change in the status of the CHANNEL ON/OFF keys.

4.3. "Programmable Configuration" menu.

This menu allows you to configure the internal routing of audio signals and the functions associated with the programmable keys, as well as define mics groups, create processes presets and manage the configuration memories (snapshots) of the unit. Clicking on the section "Programmable Configuration" on the main screen of the configuration software, a list of submenus is deployed on the left side of the workspace and that includes:

- **"Routing Configuration"**: allows you to define the cross points between input channels or internal summing buses and output channels or internal summing buses.
- **"Programmable Keys"**: allows you to configure the actions associated with each of the 20 physical programmable keys that are located in the Control and Monitoring section of AEQ FORUM LITE control surface and to each of the 100 virtual programmable keys.
- **"Mic Group Configuration"**: allows you to define microphone groups.
- **"Preset Configuration"**: allows you to create default settings associated with the various processing capabilities of AEQ FORUM LITE: equalizers, filters, compressors/limiters and noise gates.
- **"Snapshot Configuration"**: allows you to manage the configuration memories stored in the unit.

In order to access to any of these submenus, it's necessary to have a configuration loaded in the application: in case there's no configuration, the message **"Empty configuration. Please read configuration before use"** would be displayed and you should have to either connect to AEQ FORUM LITE console and read its configuration or load a configuration by means of "Import" option (see section 4.1.1 of this manual; you can find the "DemoConfiguration.LSC" file in C:\Program files\ForumLiteSetup\Demos).

4.3.1. "Routing Configuration" submenu.

"Routing Configuration" submenu is accessed, from the drop-down menu "Programmable Configuration", by clicking on the icon:

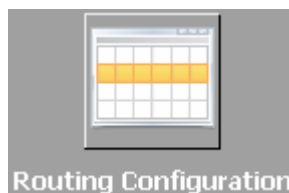

"Routing Configuration" submenu allows you to define the cross-points between input channels or internal summing buses and output channels or internal summing buses. The entire set of cross-points available on the mixing console is arranged in a table with the following fields:

- **"Id Source"**: internal numeric identifier for the input channel or summing bus.
- **"Source"**: "LABEL" of the input channel or summing bus. Please refer to sections 4.2.2 and 4.2.3 of this manual.
- **"Type"**: type of channel used in the cross-point: "Input" for input channels and "Mixer" for internal summing buses.
- **"Id Destination"**: internal numeric identifier for the output channel or summing bus.
- **"Destination"**: "LABEL" of the output channel or summing bus. Please refer to sections 4.2.2 and 4.2.3 of this manual.

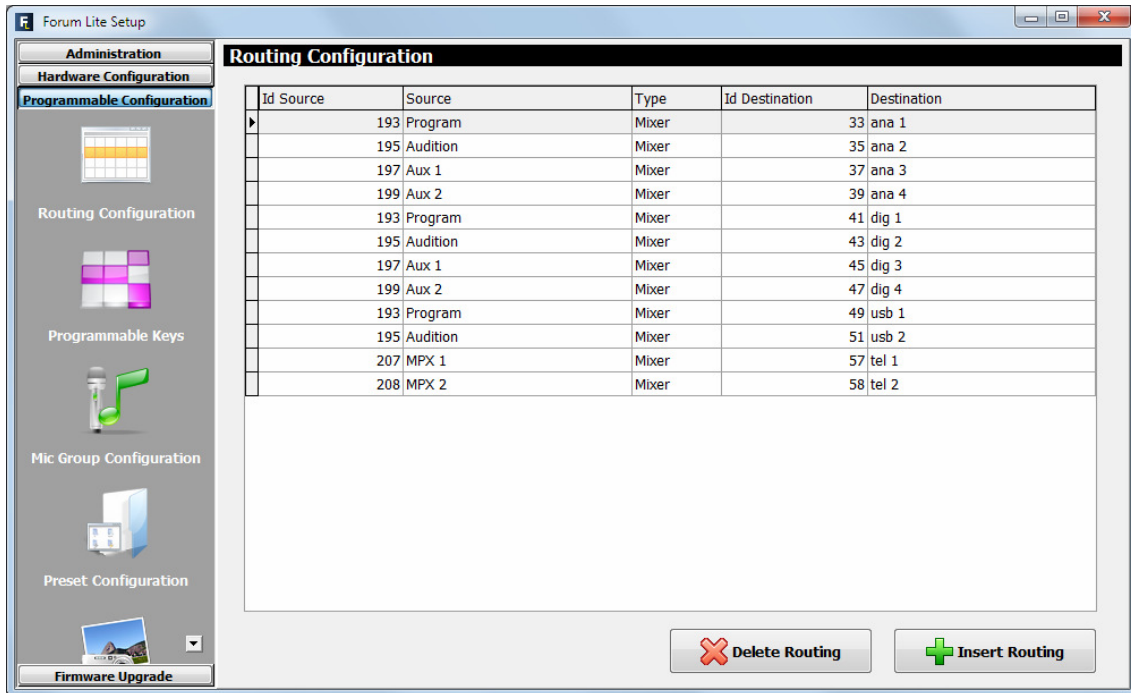

The bottom of the workspace in this submenu contains two options:

- **"Delete Routing"**: eliminates the selected cross-point. Confirmation is requested.

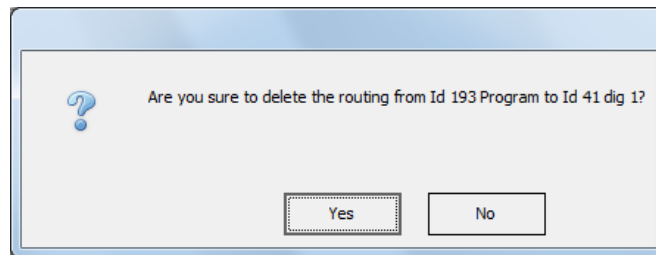

- **"Insert Routing"**: you can create a cross-point through a simple process that allows you to select an input channel or an internal summing bus as the source, and an output channel or an internal summing bus as the destination. These names or labels have been previously defined in the "I/O Configuration" submenu.

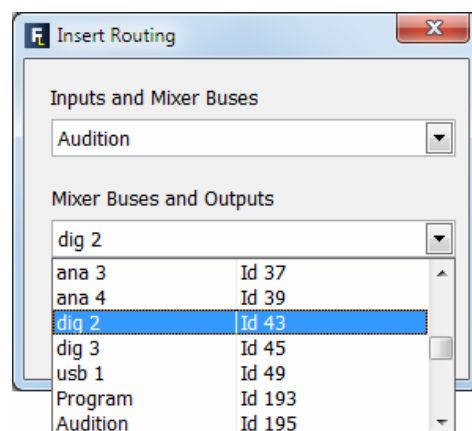
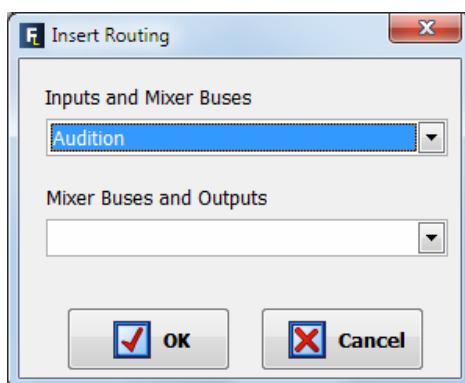

The routing toward MPX internal summing buses is saved on console configuration and it will appear in the "Routing Configuration" submenu when the active configuration is read.

4.3.2. "Programmable Keys" submenu.

"Programmable Keys" submenu is accessed, from the drop-down menu "Programmable Configuration", by clicking on the icon:



"Programmable Keys" submenu lets you configure the actions associated with each of the 20 physical programmable keys found in the Control and Monitoring section of the AEQ FORUM LITE control surface (please refer to Section 2.1.2.2 of this manual) and each of the 100 virtual programmable keys.

Within this submenu there are two distinct areas:

- **"Keyboard"**: it's the upper part of the screen that allows for the basic configuration of the 20 physical programmable keys and the 100 virtual programmable keys. In the right part of the screen you can select if physical or virtual keys will be configured (the virtual ones are divided into 5 groups of 20 keys).
- **"Key Configuration"**: it's the lower part of the screen where the specific configuration of the selected programmable key is accomplished. The **"Edit Label"** button allows you to assign a label to the programmable key in order to identify it in the future **"Forum Lite Virtual"** application.

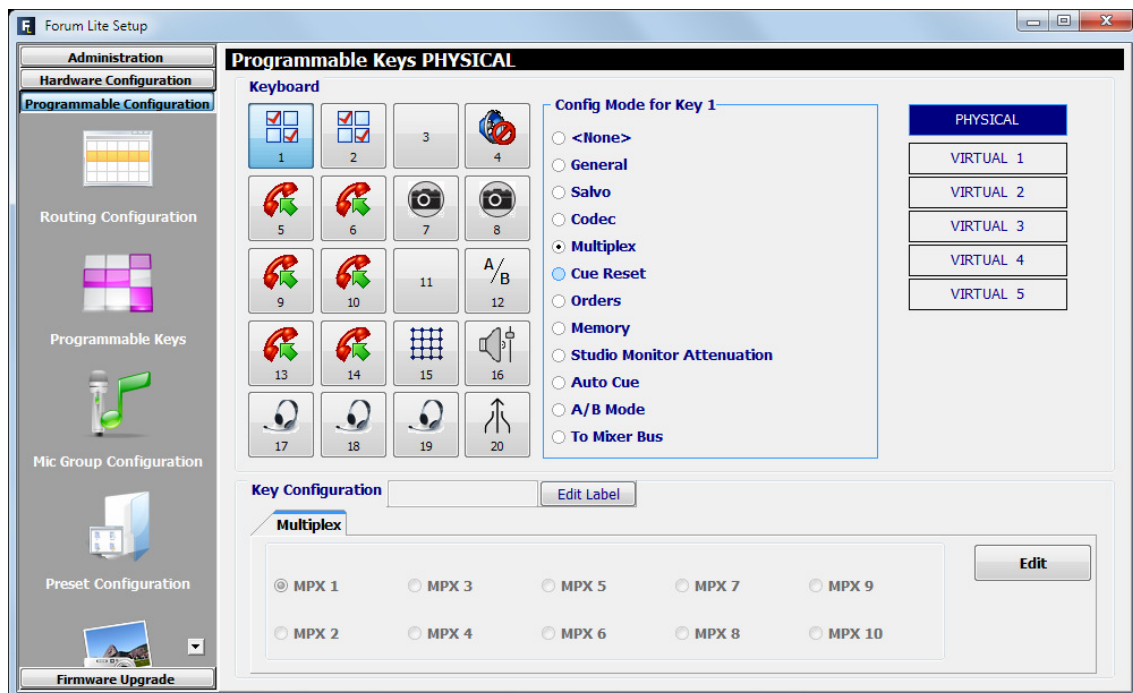

4.3.2.1. Basic configuration of programmable keys.

This basic configuration section shows graphically the programmable keys corresponding to the Control and Monitoring section of the AEQ FORUM LITE control surface. The programmable keys are numbered from 1 to 20 following the order from left to right and top to bottom.

To set a programmable key, simply click on it with the mouse and select from the list on the right to associate action. The available options are:

- **"None"**: no action associated.
- **"General"**: associated with activation of physical or virtual GPIs and/or GPOs.
- **"Salvo"**: allows you to configure activation/deactivation of a Salvo.
- **"Codec"**: associated with remote control of external communications equipment through physical or virtual GPIs and GPOs.
- **"Multiplex"**: allows you to make a quick management of signal routing toward a "MPX" type internal summing bus (these buses are typically used for sending to codecs, hybrids or other auxiliary destinations).
- **"Cue Reset"**: allows you to cancel all the signals sending to the CUE bus at that moment.
- **"Orders"**: allows you to send the orders microphone to the selected output channel.
- **"Memory"**: allows you to load the selected configuration memory or snapshot.
- **"Studio Monitor Attenuation"**: allows you to replace the studio monitors muting when a studio microphone is activated with a programmable attenuation (-10dB, -15dB or -20dB) of those monitors level.
- **"Auto Cue"**: allows you to modify the working mode of the signals sending to the CUE bus and the control monitoring.
- **"A/B Mode"**: allows you to activate the A/B working mode.
- **"To Mixer Bus"**: allows you to make a quick management of signal routing toward an "Internal" type summing bus.

In the case of the **virtual** programmable keys, only the **first 3 options** are available. As its name implies, these keys will not be physically available on the control surface and will have associated actions that will be activated by means of physical or virtual GPIs.

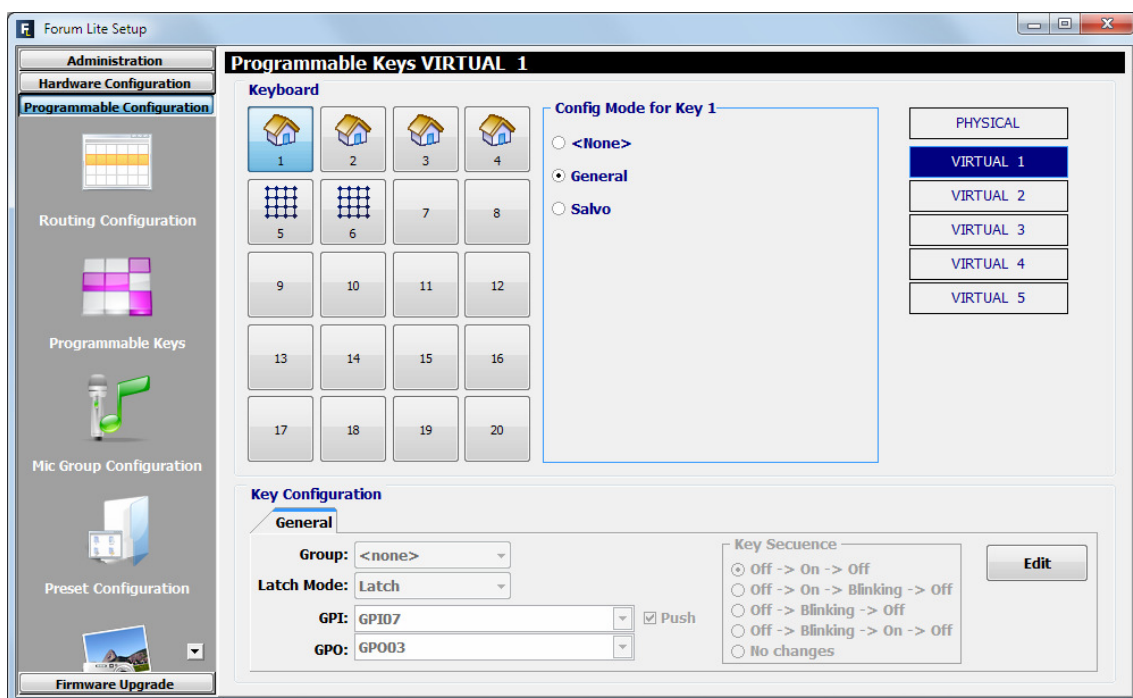

4.3.2.2. Configuration of "General" programmable keys.

Programmable keys that are set to "General" are used to activate GPIs and GPOs. A key set to this function is assigned with a dedicated icon.



The lower part of the "Programmable Keys" submenu will show the associated options for "General" type keys, when this configuration mode is selected:

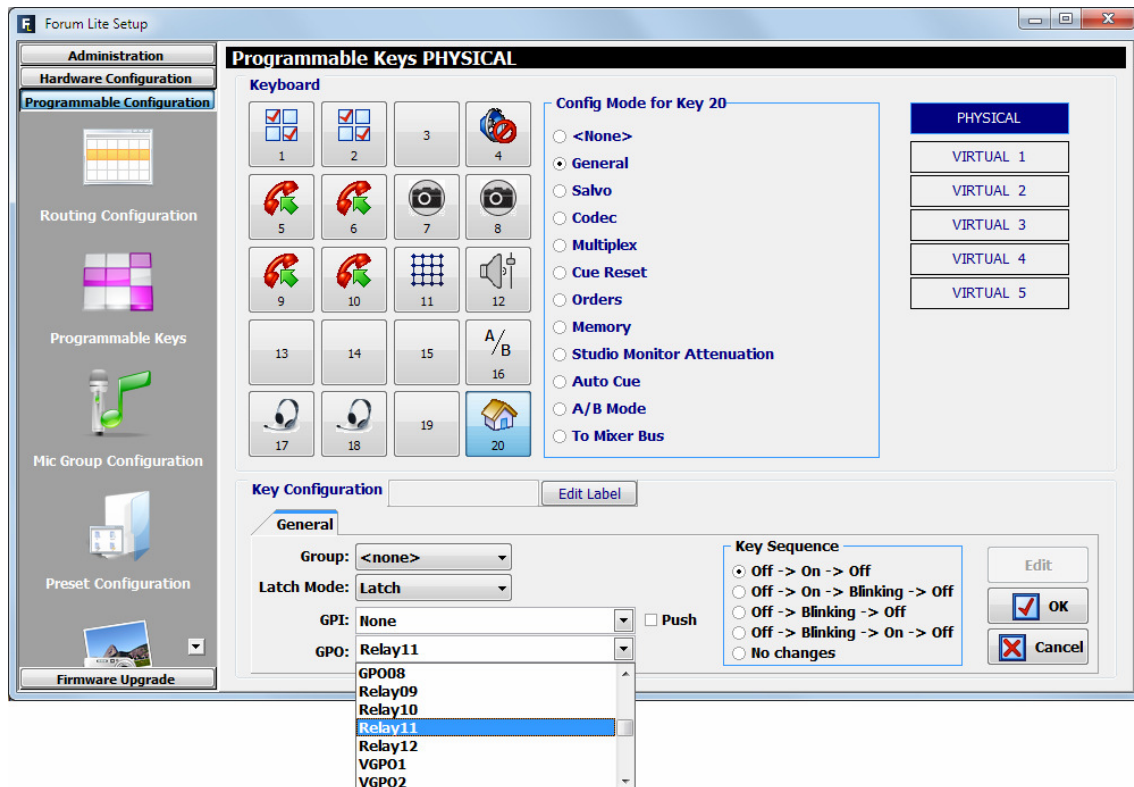

In order to be able to configure the programmable key (or edit a previously created configuration), you have to press the "Edit" button, to active and allows you to configure the following fields:

- **"Group"**: allows you to assign the programmable key to a group. Assign a key to a group when you need to define exclusive operation between various programmable keys (the activation of one of them entail the deactivation of the one active at that moment). You can create up to 8 programmable keys groups. "None" indicates that key is not assigned to a group.
- **"Latch Mode"**: allows you to configure the key as "Latch" or "Non Latch", so after you press it, the key stays fixed or not. When a key is configured as "Non Latch", it executes the associated function only while it remains pressed.
- **"GPI"**: allows you to select the physical or virtual GPI input, in the section of system common I/O's, associated with the programmable key activation.

- **"Push"**: when you associates a GPI and a GPO to the same key and you active this checkbox, the GPO is automatically activated when GPI is received. When "Push" checkbox is not active, this automatic activation is not made. Any of them can be physical or virtual.
- **"GPO"**: allows you to select the physical or virtual GPO output, in the section of system common I/O's, associated with the programmable key activation. When a GPO already used is selected, a warning message will appear.
- **"Key Sequence"**: allows you to select the operating sequence of the programmable key:
 - **"Off-On-Off"**: initially the key is off, it turns on when the programmable key is pressed (or when the associated GPI is activated) and off when it's pressed again (or when the GPI is deactivated). From this point the cycle is re-initiated.
 - **"Off-On-Blinking-Off"**: initially the key is off, it turns on when the programmable key is pressed, starts blinking when the key is pressed again and turn off when it's pressed again. From this point the cycle is re-initiated. When activation is through an associated GPI, the key turns on when the GPI is activated and starts blinking when it's deactivated.
 - **"Off-Blinking-Off"**: initially the key is off, it starts blinking when the programmable key is pressed (or when the associated GPI is activated) and off when it's pressed again (or when the GPI is deactivated). From this point the cycle is re-initiated.
 - **"Off-Blinking-On-Off"**: initially the key is off, it starts blinking when the programmable key is pressed, turns on when the key is pressed again and turn off when it's pressed again. From this point the cycle is re-initiated. When activation is through an associated GPI, the key starts blinking when the GPI is activated and turns off when it's deactivated.
 - **"No changes"**: this option is exclusively associated with GPIs. The key turns on when GPI is activated and keeps on until that GPI is deactivated, even if the key is pressed.
- **"OK"**: allows you to accept the created or edited configuration.
- **"Cancel"**: allows you to reject the created or edited configuration. No change you may have made is saved.

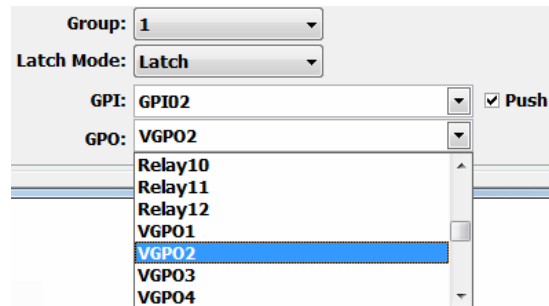
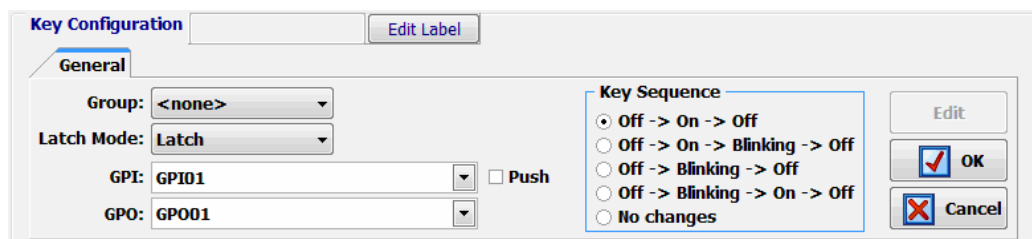
In the case of the **virtual** programmable keys, only the "GPI" that will activate the key and the associated "GPO" should be configured. Besides, the "Push" checkbox must be activated.

4.3.2.3. Configuration of "Salvo" programmable keys.

Programmable keys that are set to "Salvo" are used to activate/deactivate a Salvo or group of connections and/or disconnections of several cross-point. A key set to this function is assigned with a dedicated icon.



The lower part of the "Programmable Keys" submenu will allow you to configure the Salvo content.

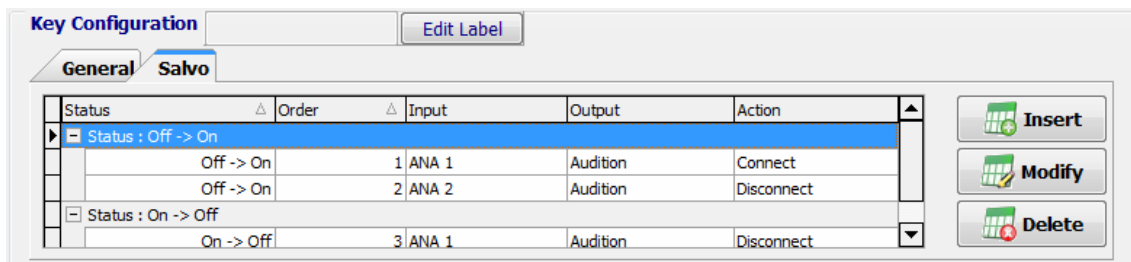

There are two tabs: "General" y "Salvo".

The "General" tab gives you access to a screen identical to the one described in the previous section and allows you to configure the operational sequence of the programmable key and its relationship with the system GPI's and GPO's. This way it is possible to execute a Salvo by pressing the programmable key and activating at the same time a GPO or by the remote activation of the programmable key through GPI (for this purpose, you must activate the "Push" checkbox). When a GPO already used is selected, a warning message will appear.

The only difference in this tab with respect to the "General" type programmable keys is that the "HW Switch" option appears, which allows you to assign this working mode to a group of keys:

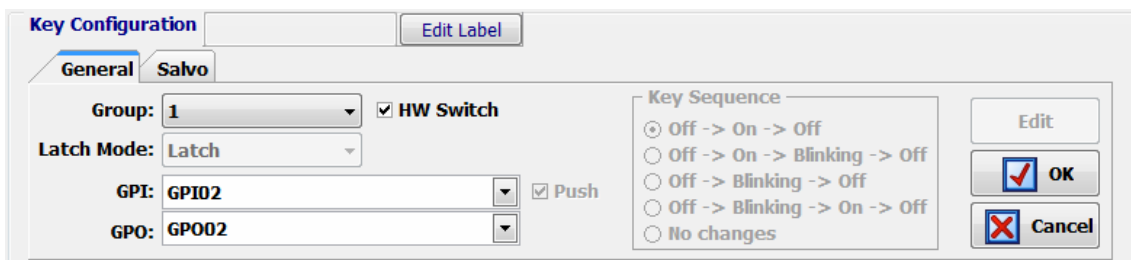

In order to activate this option, the programmable key must be assign to a group. When activated, there are certain fields that are configured by default and cannot be modified: "Latch Mode" is configured as "Latch", "Push" is activated and "Key Sequence" is configured as "Off-On-Off". When you activate/deactivate the "HW Switch" option on a key and validate by pressing "OK", in the other programmable keys of "Salvo" type that belong to the same group, that option is automatically activated/deactivated and the configuration of the three previous fields is replicated..

The "Salvo" tab includes specific functions, including a list of actions for each of the cross-points controlled by the Salvo and the order of execution (first-up, last-down). There are three buttons below the list enabling you to configure the list of actions:

- **"Insert"**: allows you to insert the activation or deactivation of a cross-point in the list of actions from a simple menu:
 - **"Status"**:
 - **"Off → On"**: the action is executed when the programmable key is activated.
 - **"On → Off"**: the action is executed when the programmable key is deactivated.
 - **"Order"**: allows you to set the position of this action in the general list of actions.
 - **"Input"**: allows you to select the input channel or internal summing bus.
 - **"Output"**: allows you to select the output channel or internal summing bus.
 - **"Action"**: allows you to select whether the cross-point between "Input" y "Output" is connected ("Connect") or disconnected ("Disconnect").

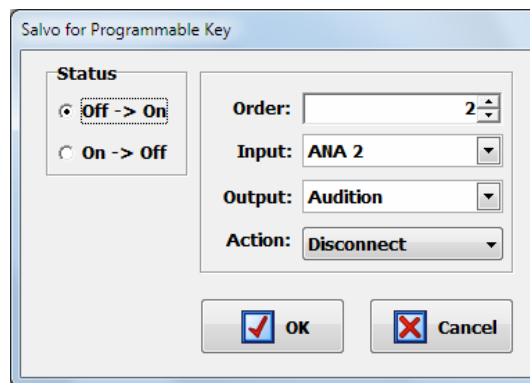

- **"Modify"**: allows you to modify a preconfigured action. The options on this screen are identical to those described for "Insert" option.
- **"Delete"**: allows you to delete a preconfigured action. Confirmation is requested.

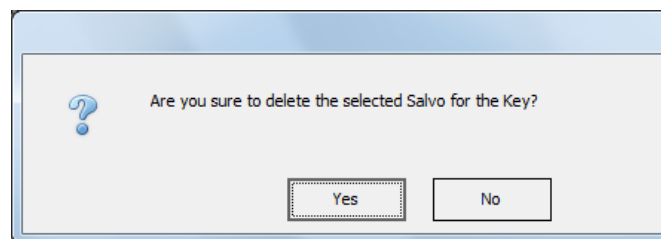

In the case of the **virtual** programmable keys, at least the "GPI" that will activate remotely the key to execute the Salvo should also be configured.

4.3.2.4. Configuration of "Codec" programmable keys.

Programmable keys that are set to "Codec" enables you to assign functions associated with remote control of external communications equipment (such as audiocodecs) through associated physical or virtual GPIs and GPOs. A key set to this function is assigned with a dedicated icon.

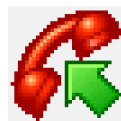

The lower part of the "Programmable Keys" submenu will show the associated options for "Codec" type keys, when this configuration mode is selected.

In order to be able to configure the programmable key (or edit a previously created configuration), you have to press the **"Edit"** button, to active and allows you to configure the following fields:

- **"Device"**: shows a list of pre-programmed devices in the "Codec" function. The available options are:
 - **"CA33"**: optional internal dual digital telephone hybrid module of AEQ FORUM LITE. For more information see section 2.2.4.3 of this manual.
 - **"TH02"**: digital telephone hybrid AEQ TH02EX. For more information please consult the AEQ website.
 - **"Eagle"**: ISDN audiocodec AEQ EAGLE. For more information please consult the AEQ website.
 - **"Phoenix"**: IP/ISDN audiocodec AEQ PHOENIX Studio, Stratos, Venus, Venus V2, Venus V3 or Venus V4. For more information please consult the AEQ website.

Depending on the particular equipment selected, the following options may vary. For **CA33** module, the available configuration options are:

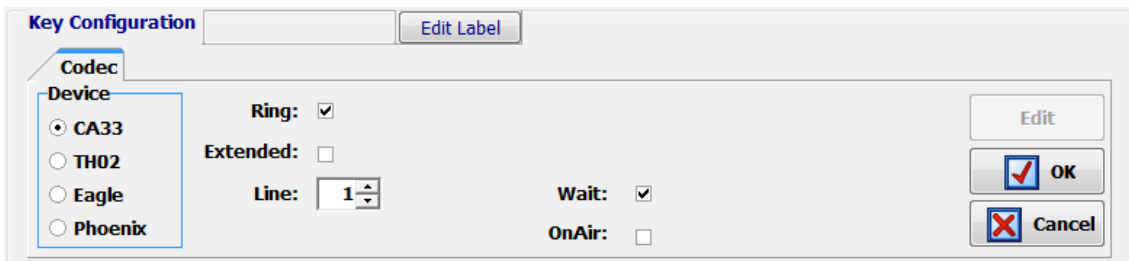

- **"Ring"**: the key starts to blink when there is an incoming call. This function can be combined in the same key with any of the following three functions.
- **"Extended"**: enables the option of frequency extender for the CA33 telephone hybrid. The key turns on when activated.
- **"Line"**: selects which of the two CA33 lines that key is configured for.
- **"Wait"**: allows you to put the call on hold (you can send audio to the telephone line, but the audio from the line is not received in the console). The key turns on when activated.
- **"OnAir"**: allows you to put the call on the air (you can send audio to the telephone line and the audio from the line is received in the console). The key turns on when activated.
- **"OK"**: allows you to accept the created or edited configuration.
- **"Cancel"**: allows you to reject the created or edited configuration. No change you may have made is saved.

IMPORTANT NOTE: "Extended", "Wait" and "OnAir" functions are exclusive between them (a programmable key can have only one of the three options associated), although any of them can be combined in the same key with "Ring" function.

For **TH02** hybrid, the available configuration options are:



- **"Ring"**: allows you to select the GPI where the incoming call signal provided by the hybrid is wired. The key starts to blink when there is an incoming call. This function can be combined in the same key with any of the following three functions.
NOTE: the working mode of the selected **GPI** must be previously configured as **"TH02"** (see section 4.2.1.1 of this manual).
- **"Extended"**: enables the option of frequency extender for the TH02 telephone hybrid and select the GPO used to send the remote control signal to the hybrid. The key turns on when activated.
- **"Wait GPO"**: selects and configures the physical GPO output associated with "WAIT" function. The key turns on when activated and puts the call on hold (WAIT mode).
- **"On Air GPO"**: selects and configures the physical GPO output associated with "ON AIR" function. The key turns on when activated and puts the call on the air (ON AIR mode).
- **"Line"**: for dual line hybrids such as TH02, this identifies the integrated line 1 and line 2, to assign the different GPIs and GPOs for remote control
- **"OK"**: allows you to accept the created or edited configuration.
- **"Cancel"**: allows you to reject the created or edited configuration. No change you may have made is saved.

IMPORTANT NOTE: "Extended", "Wait GPO" and "OnAir GPO" functions are exclusive between them (a programmable key can have only one of the three options associated), although any of them can be combined in the same key with "Ring" function. In addition, when a GPO already used is selected, a warning error message will appear.

For **Eagle** audiocodec, the available configuration options are:

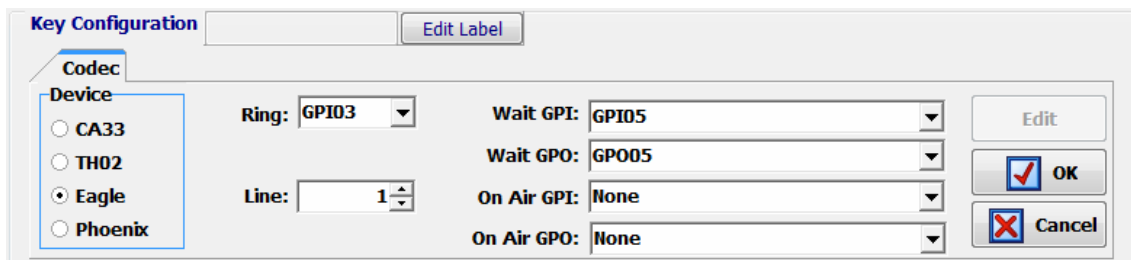

The screenshot shows a 'Key Configuration' dialog box with an 'Edit Label' button. Under the 'Codec' tab, the 'Device' section has radio buttons for CA33, TH02, Eagle (selected), and Phoenix. The configuration fields are: Ring: GPI03 (dropdown), Line: 1 (spinner), Wait GPI: GPI05 (dropdown), Wait GPO: GPO05 (dropdown), On Air GPI: None (dropdown), and On Air GPO: None (dropdown). Action buttons include Edit, OK (checked), and Cancel (X).

- **"Ring"**: allows you to select the GPI where the incoming call signal provided by the codec is wired. The key starts to blink when there is an incoming call. This function can be combined in the same key with any of the following four functions.
- **"Wait GPI"**: selects and configures the physical GPI input associated with "WAIT" function. The key turns on when WAIT mode (call on hold) is activated manually in the audiocodec.
- **"Wait GPO"**: selects and configures the physical GPO output associated with "WAIT" function. The key turns on when activated and puts the call on hold (WAIT mode).
- **"On Air GPI"**: selects and configures the physical GPI input associated with "ON AIR" function. The key turns on when ON AIR mode (call on the air) is activated manually in the audiocodec.
- **"On Air GPO"**: selects and configures the physical GPO output associated with "ON AIR" function. The key turns on when activated and puts the call on the air (ON AIR mode).
- **"Line"**: for dual line codecs such as Eagle, this identifies the integrated line 1 and line 2, to assign the different GPIs and GPOs for remote control.
- **"OK"**: allows you to accept the created or edited configuration.
- **"Cancel"**: allows you to reject the created or edited configuration. No change you may have made is saved.

IMPORTANT NOTE: The pairs of functions "Wait GPI"- "Wait GPO" and "On Air GPI"- "On Air GPO" are exclusive between them (a programmable key can have only one of the two pairs associated). In addition, when a GPO already used is selected, a warning message will appear.

For Codecs it is usual to program at least two programmable keys per channel: one to share "Ring", "Wait GPI" and "Wait GPO" functions and another one to share "On Air GPI" and "On Air GPO" functions. The following screens show an example of programmable keys configuration for remote control of an AEQ EAGLE audiocodec.

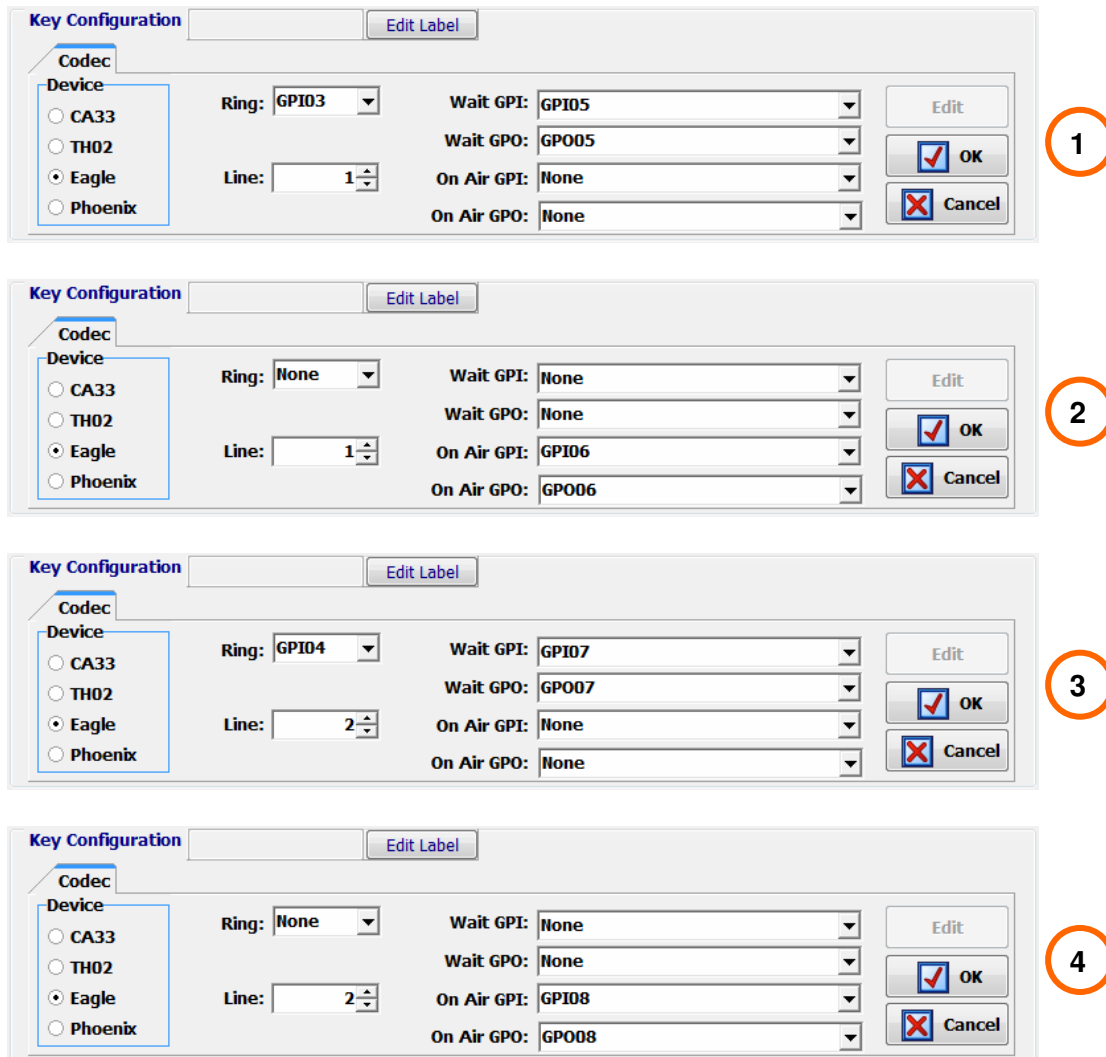
1

Device: Eagle
 Ring: GPI03
 Wait GPI: GPI05
 Wait GPO: GPO05
 On Air GPI: None
 On Air GPO: None

2

Device: Eagle
 Ring: None
 Wait GPI: None
 Wait GPO: None
 On Air GPI: GPI06
 On Air GPO: GPO06

3

Device: Eagle
 Ring: GPI04
 Wait GPI: GPI07
 Wait GPO: GPO07
 On Air GPI: None
 On Air GPO: None

4

Device: Eagle
 Ring: None
 Wait GPI: None
 Wait GPO: None
 On Air GPI: GPI08
 On Air GPO: GPO08

For **Phoenix Studio, Stratos, Venus, Venus V2, Venus V3 or Venus V4** audiocodec, the available configuration options are:



Device: Phoenix
 Ring: GPI06
 Call GPO: None
 On Air GPO: GPO06

- **"Ring"**: allows you to select the physical or virtual GPI where the incoming call signal provided by the codec is wired or addressed. The key starts to blink when there is an incoming call. This function can be combined in the same key with any of the following four functions.

- **"Call GPO"**: selects and configures the physical or virtual GPO output associated with "CALL" function. The key turns on when activated and makes the call from the corresponding channel.
- **"On Air GPO"**: selects and configures the physical or virtual GPO output associated with "ON AIR" function. The key turns on when activated and puts the call on the air (ON AIR mode).
- **"Line"**: identifies the integrated line 1 and line 2, to assign the different GPIs and GPOs for remote control.
- **"OK"**: allows you to accept the created or edited configuration.
- **"Cancel"**: allows you to reject the created or edited configuration. No change you may have made is saved.

IMPORTANT NOTE: The functions "Call GPO" and "On Air GPO" are exclusive between them (a programmable key can have only one of the two functions associated). In addition, when a GPO already used is selected, a warning message will appear.

4.3.2.5. Configuration of "Multiplex" programmable keys.

Programmable keys that are set to "Multiplex" enables you to make a quick management of signal routing toward a "MPX" type internal summing bus (these buses are typically used for sending to codecs, hybrids or other auxiliary destinations). A key set to this function is assigned with a dedicated icon.



The lower part of the "Programmable Keys" submenu will show the associated options for "Multiplex" type keys, when this configuration mode is selected. In order to be able to configure the programmable key (or edit a previously created configuration), you have to press the **"Edit"** button, to active and allows you to assign to that key one of the 10 available "MPX" buses:

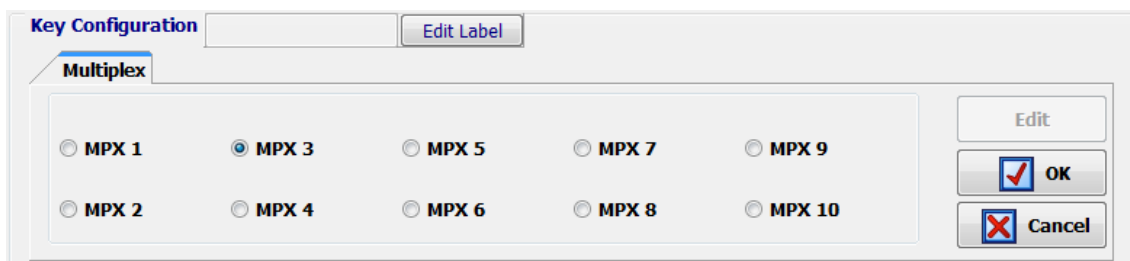

These keys works as follows: when you press and keep pressed the key you can activate the routing toward the associated "MPX" bus of any audio input channel assigned to a fader at that moment. To activate that routing, you just have to press the **"SELECT"** key of the desired channel/s (the associated LED turns on) while programmable key is pressed; by pressing again the "SELECT" key that routing is deactivated (the associated LED turns off). When you stop pressing the programmable key, the activated "SELECT" keys turns off and they recover its original function.

NOTE: This type of keys is usually associated with the operation of the "MPX" buses in "Multiplex" mode, although they can also be used with buses configured in "Clean Feed" mode. See section 4.2.2.1 of this manual.

IMPORTANT NOTE: The routing toward MPX internal summing buses is saved on console configuration and it will appear in the "Routing Configuration" submenu when the active configuration is read.

4.3.2.6. Configuration of "Cue Reset" programmable key.

"Cue Reset" option allows you to configure a programmable key as a key to disconnect immediately all the signal sendings to the CUE bus at that moment. A key set to this function is assigned with a dedicated icon.



The lower part of the "Programmable Keys" submenu will show no options when this configuration mode is selected.

The activation of this "Cue Reset" function will have the following result in AEQ FORUM LITE control surface: when the key is pressed, all the circuits or channels being sent to the CUE bus of the mixer will be disconnected and the LEDs of all the "CUE" keys that may be active will be turned off.

IMPORTANT NOTE: By default, this function is associated with "CUE RESET" key in control room monitoring section (see section 2.1.2.4 of this manual). When in addition a programmable key is set to this function, both will work in parallel.

4.3.2.7. Configuration of "Orders" programmable keys.

Programmable keys that are set to "Orders" enables you to send the orders microphone to the selected output channel. A key set to this function is assigned with a dedicated icon.



The lower part of the "Programmable Keys" submenu will allow you to configure the output associated with the programmable key. In order to be able to configure the programmable key (or edit a previously configured key), you have to press the "Edit" button, to active and allows you to assign to that key any of the outputs defined in the system.



These keys works as follows: when you press and keep pressed the key you send to the selected output the orders microphone (any routing previously defined for that output is deactivated). When you stop pressing the programmable key, you stop sending the orders microphone and the previous routing is recovered.

4.3.2.8. Configuration of "Memory" programmable keys.

Programmable keys that are set to "Memory" allows you to load the selected configuration memory or snapshot. A key set to this function is assigned with a dedicated icon.



The lower part of the "Programmable Keys" submenu will allow you to configure the memory or snapshot associated with the programmable key. In order to be able to configure the programmable key (or edit a previously configured key), you have to press the "Edit" button, to active and allows you to assign to that key any of the memories defined in the system.



IMPORTANT NOTE 1: When you press the key the configuration stored in the selected memory is directly loaded into the console. In this case no confirmation is requested (the system will ask for confirmation only when the memory is loaded from the "MEMORY" menu: see section 3.3 of this manual).

IMPORTANT NOTE 2: When a new configuration memory or snapshot is loaded, the audio of the activated channel or channels (ON AIR) will not be interrupted (and the associated routing will remain) provided that in the new memory the activated channels are placed in the same fader positions. The routing toward MPX internal summing buses of any signal will also remain (whether the signal is ON AIR or not).

4.3.2.9. Configuration of "Studio Monitor Attenuation" programmable keys.

Programmable keys that are set to "Studio Monitor Attenuation" allows you to replace the studio monitors muting when a studio microphone is activated (or any other channel with "Studio On Air" option activated: see section 4.2.3.1 of this manual) with a programmable attenuation (-10dB, -15dB or -20dB) of those monitors level. A key set to this function is assigned with a dedicated icon.

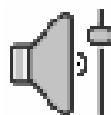

The lower part of the "Programmable Keys" submenu will allow you to configure the attenuation associated with the programmable key. In order to be able to configure the programmable key (or edit a previously configured key), you have to press the "Edit" button, to active and allows you to assign to that key any of the 3 available attenuations: -10dB, -15dB and -20dB.

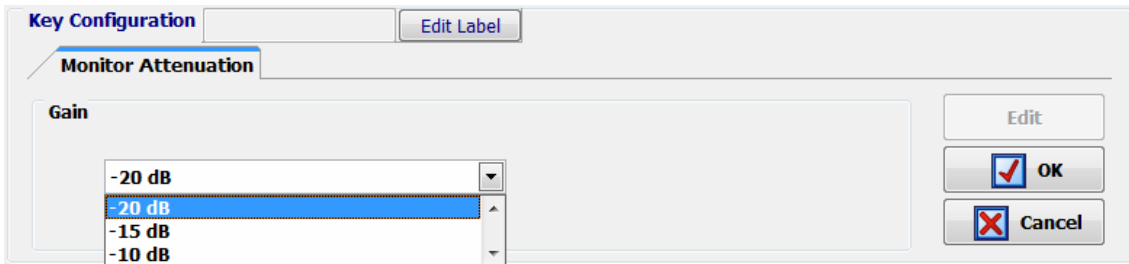

These keys work as follows: when the "Studio Monitor Attenuation" key is not pressed, the studio monitors are muted when a studio microphone is activated.

When you press the key, it turns on and the studio monitors are attenuated when a microphone is activated according to the previous programming (-10dB, -15dB or -20dB). When you press the key again, it turns off and the studio monitors return to initial operation.

When there are several "Studio Monitor Attenuation" keys defined, the operation is exclusive, it's not possible to turn on more than one key simultaneously (the activation of one of them entails the deactivation of the one active at that moment and the corresponding modification of the attenuation).

4.3.2.10. Configuration of "Auto Cue" programmable key.

"Auto Cue" option allows you to configure a programmable key to modify the working mode of the signals sending to the CUE bus and the control monitoring. A key set to this function is assigned with a dedicated icon.

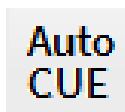

When you press the key, it turns on and, if there is one or more signals sent to CUE, they are deactivated. In addition, the CUE keys become exclusive, it's not possible to turn on more than one key simultaneously (the activation of one of them entails the deactivation of the one active at that moment). Finally, when a signal is sent to CUE, in control monitoring section the signal selected at that moment ("PROG", "AUD", "SEL" or "CUE") is no longer monitored and the last activated CUE is then monitored. When that CUE sending is deactivated, the previously selected signal is monitored again.

When this function is deactivated by pressing again the "Auto Cue" key, it turns off and, if there is a signal sent to CUE, it is deactivated. In addition, the CUE keys stop working exclusively and control monitoring returns to its normal working mode.

4.3.2.11. Configuration of "A/B Mode" programmable key.

"A/B Mode" option allows you to configure a programmable key to activate the A/B working mode. A key set to this function is assigned with a dedicated icon.

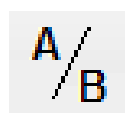

This key works as follows: when you press and keep pressed the key, it turns on and activates the A/B working mode in order to be able to accomplish a fast change of the input assigned to one or more channels. To activate that change, you just have to press the "SELECT" key of the desired channel (the associated LED turns on for a while) while programmable key is pressed in order to load the input defined as B in the snapshot for that channel and show it in the channel.

display. By pressing again the "SELECT" key you can assign again signal A to the channel. If you press the "SELECT" key of a channel with no signal B defined, logically no change occurs. When you stop pressing the "A/B" programmable key, it turns off and the "SELECT" keys recover its original function.

This key allows you to configure any other operating mode of the channel activation keys (see section 4.3.5 of this manual) and momentarily switch to A/B mode without needing to load another configuration memory or snapshot.

4.3.2.12. Configuration of "To Mixer Bus" programmable keys.

Programmable keys that are set to "To Mixer Bus" enables you to make a quick management of signal routing toward an "Internal" type summing bus. A key set to this function is assigned with a dedicated icon.



The lower part of the "Programmable Keys" submenu will allow you to configure the summing bus associated with the programmable key. In order to be able to configure the programmable key (or edit a previously configured key), you have to press the "Edit" button, to active and allows you to assign to that key any of the summing buses (of "Internal" type) defined in the system.



These keys works as follows: when you press and keep pressed the key you can activate the routing toward the associated summing bus of any audio input channel assigned to a fader at that moment. To activate that routing, you just have to press the "SELECT" key of the desired channel/s (the associated LED turns on) while programmable key is pressed; by pressing again the "SELECT" key that routing is deactivated (the associated LED turns off). When you stop pressing the programmable key, the activated "SELECT" keys turns off and they recover its original function.

4.3.3. "Mic Group Configuration" submenu.

"Mic Group Configuration" submenu is accessed, from the drop-down menu "Programmable Configuration", by clicking on the icon:



"Mic Group Configuration" submenu allows you to define groups of microphones. Within this submenu there are two distinct areas on the screen:

- The left side shows the list of groups of microphones set up.
- The right side shows the list of the microphone inputs that are part of the group selected at that moment in the left part of the screen.

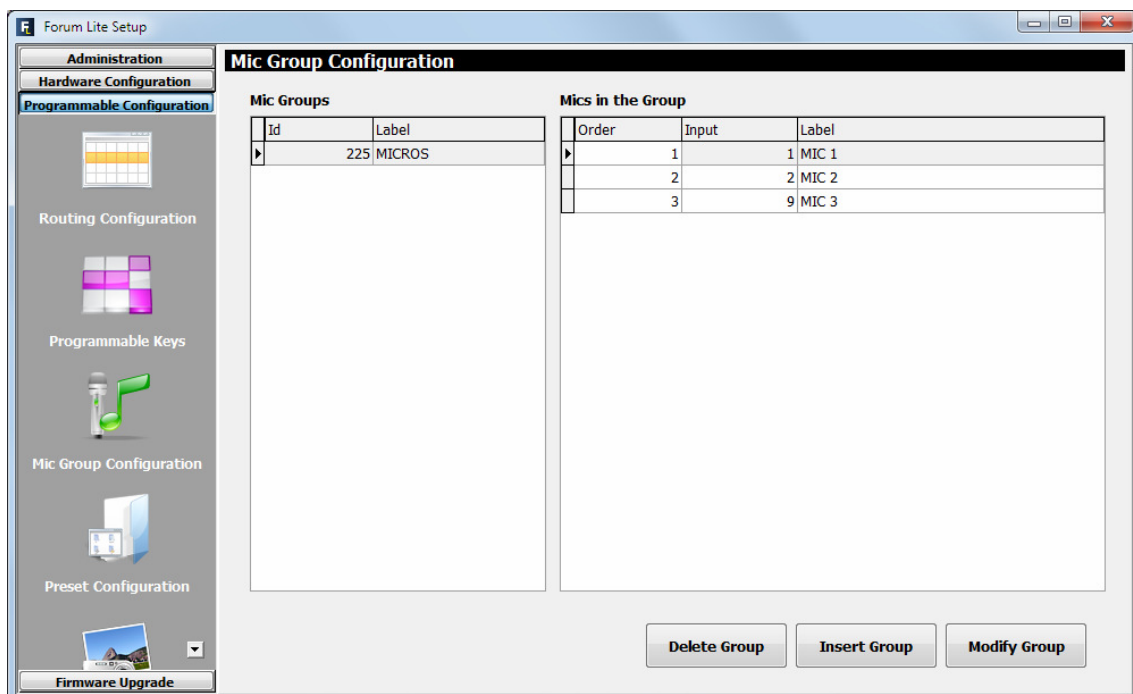





The three buttons at the bottom of the screen allow you to manage the list of groups of microphones and their individual configuration.

- **"Delete Group"**: deletes the selected group of microphones. Confirmation is requested.



- **"Insert Group"**: creates a new group of microphones and allows you to insert and set up the signals through the following menu options:

- **"Label"**: name or ID for the group of microphones. A maximum of 6 characters is recommended.
-  adds ALL microphones or audio inputs from the "Inputs available" column to the "Inputs in the Group" column.
-  adds ONLY the microphone or audio input selected from the "Inputs available" column to the "Inputs in the Group" column.
-  removes ONLY the microphone or audio input selected from the "Inputs in the Group" column back to the "Inputs available" column.
-  removes ALL the microphones or audio inputs from the "Inputs in the Group" column back to the "Inputs available" column.
- **"OK"**: allows you to accept the created or edited configuration.
- **"Cancel"**: allows you to reject the created or edited configuration. No change you may have made is saved.

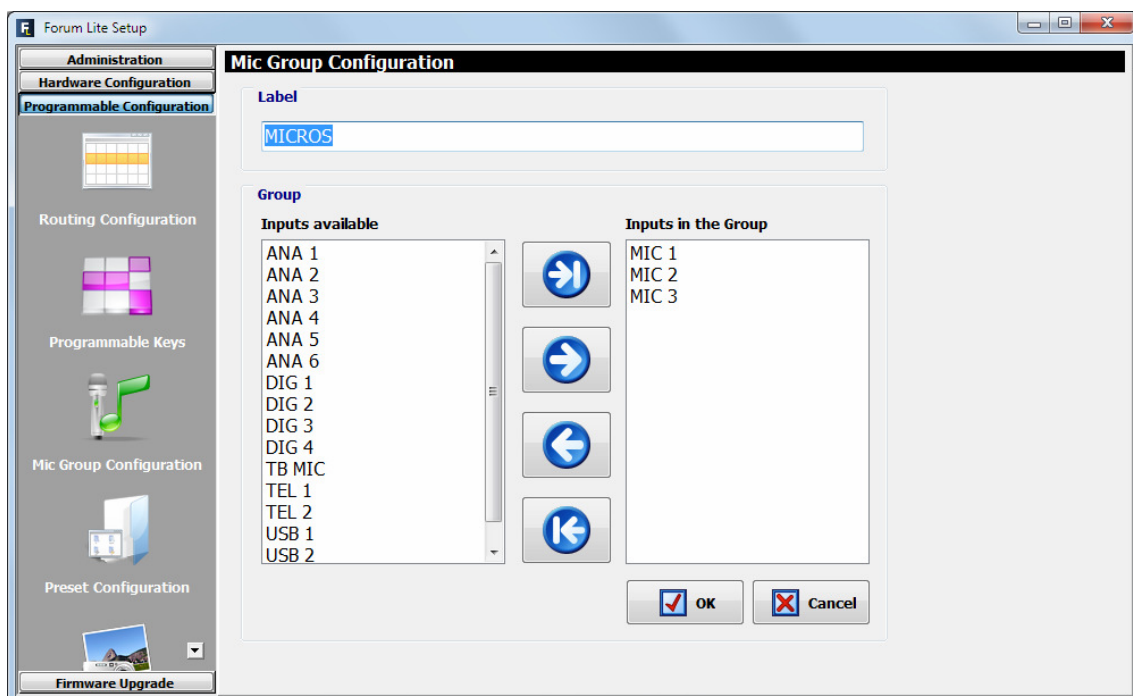

- **"Modify Group"**: allows you to modify the selected and previously created group of microphones. The menu is identical to previously described for "Insert Group" option.

4.3.4. "Preset Configuration" submenu.

"Preset Configuration" submenu is accessed, from the drop-down menu "Programmable Configuration", by clicking on the icon:







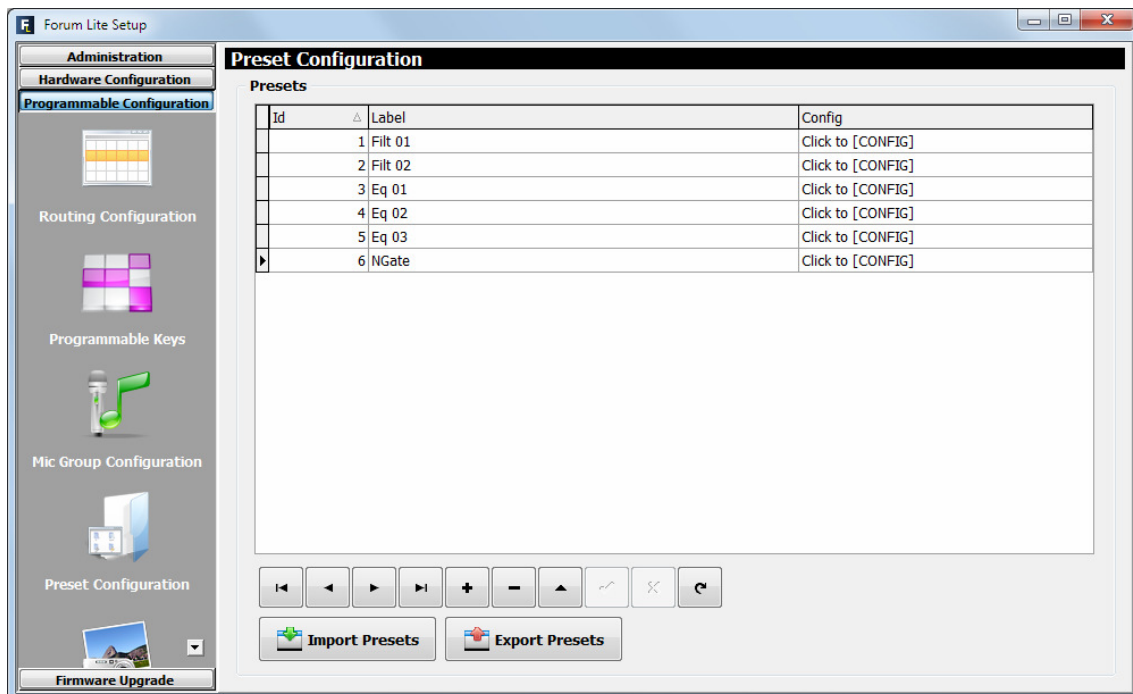





"Preset Configuration" submenu allows you to create default settings associated with the different audio processes available in AEQ FORUM LITE: equalizers, filters, compressors/limiters and noise gates.

The main screen of this submenu is presented as a list of all the pre-sets created ordered by their "Id" and with a "Label" or name as identifier.



The lower part of the "Preset Configuration" submenu includes a set of standardized buttons to manage the list of presets:

- | | |
|--|---|
|  | Allows you to scroll to the top of the list. |
|  | Allows you to move to the position immediately above in the list. |
|  | Allows you to move to the position immediately below in the list. |
|  | Allows you to scroll to the last position of the list. |
|  | Allows you to insert a new entry in the list. |
|  | Allows you to delete the selected entry from the list. Confirmation is requested. |
|  | Allows you to edit the selected entry. |
|  | Allows you to accept changes to the selected entry. |
|  | Allows you to reject to the selected entry. |
|  | Allows you to refresh the information shown in the list. |

The main screen of this submenu has also two buttons at the bottom:

- **"Import Presets"**: allows you to import to "Forum Lite Setup" application all pre-sets stored on an AEQ FORUM LITE mixing console that is connected through IP to the computer where the application is installed.
- **"Export Presets"**: allows you to export from "Forum Lite Setup" application all stored pre-sets to an AEQ FORUM LITE mixing console that is connected through IP to the computer where the application is installed.

The advanced configuration menu of each one of the stored pre-sets is accessed by clicking **"Click to [CONFIG]"** and then clicking again on the  button that will appear. The screen you access to looks as follows:

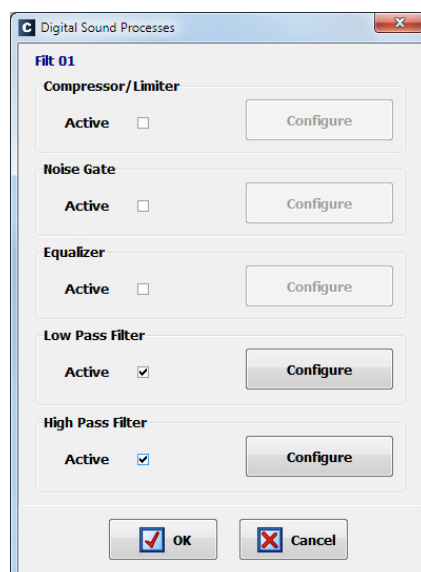

4.3.4.1. Advanced configuration of Compressor/Limiter.

From the initial screen of the pre-sets advanced information menu ("Digital Sound Processes") you can configure and activate/deactivate the Compressor/Limiter operation.

When you select the "Active" checkbox, the "**Configure**" button gets active and gives you access to the graphic display where the Compressor/Limiter associated parameters can be modified.

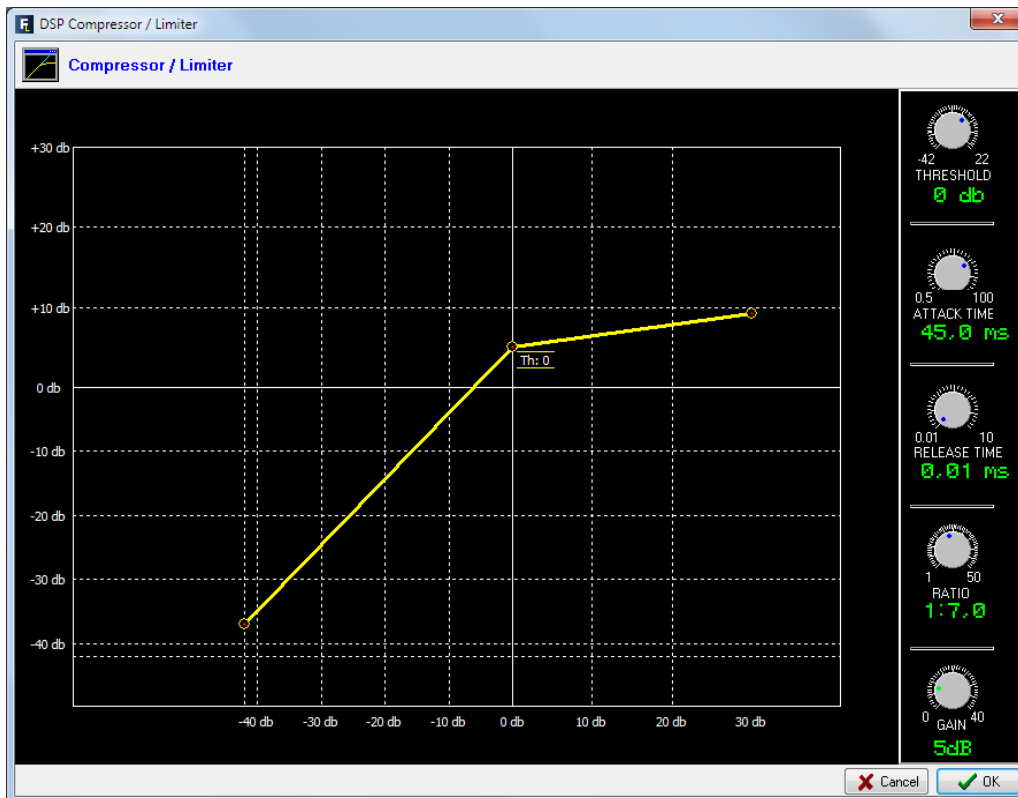

Dynamics processors are used to modify the dynamic ranges of an audio signal to adapt it to specific needs or to produce certain sound effects. A compressor enables you to reduce the dynamic range of the signal. Your purpose may be to adapt a signal with a very broad dynamic range to a circuit that will not support such wide variations in level, or to generate a certain sound in a signal.

The graph represents the variation produced in the different levels of the signal applied to this function. On the horizontal axis are the input levels, while the vertical axis shows output levels.

The "Compressor/Limiter" function acts as a "constant gain" compressor; that is, below the threshold, all input signals are amplified (or not amplified) equally, while above the threshold, the input levels are reduced to a greater or lesser degree according to the compression ratio.

If the compression range selected is the maximum, the function will act as a limiter in such a way that the signals that exceed the selected threshold at input will not exceed a certain level at output. For example, with a threshold = 0 dB, a gain of 10 dB and a compression ratio of 1:50, you will ensure that all the signals that exceed 10 dB at input will also be output at 10 dB, while the signals that are below the threshold will have an overall gain of 10 dB.

The available controls are:

- "THRESHOLD": this is the threshold above which the compressor will act. Signal levels that exceed this threshold will be affected by the compressor settings. The threshold range varies from -42dB to +22dB.

- "ATTACK TIME": this is the time it takes the compressor to react to an increase in the input signal. It ranges between 0.5 and 100 ms.
- "RELEASE TIME": this is the maintenance time during which the compressor keeps acting, even when the level of the input signal has fallen below the threshold. It ranges between 0.01 and 10 s.
- "RATIO": this is the compression ratio. A ratio of 1:1 does not involve any variation in the signal, as the level of the input signal is maintained at the output. A ratio of 1:1 indicates that the level of an input signal which exceeds the threshold will be reduced to half at the output. The highest ratio available is 1:50, which will be used to implement signal limiters. The limiter must reduce all signals exceeding a certain level to that level.
- "GAIN": this enables you to apply a general gain to the signal. This entails a general increase of the signal level, which will be especially noted at low input levels that are under the threshold set. It ranges between 0 and 40dB.
- "OK": allows you to accept the created or edited configuration. A double confirmation is required.
- "Cancel": allows you to reject the created or edited configuration. No change you may have made is saved.

4.3.4.2. Advanced configuration of Noise Gate.

From the initial screen of the pre-sets advanced information menu ("Digital Sound Processes") you can configure and activate/deactivate the Noise Gate operation.

When you select the "Active" checkbox, the "**Configure**" button gets active and gives you access to the graphic display where the Noise Gate associated parameters can be modified.

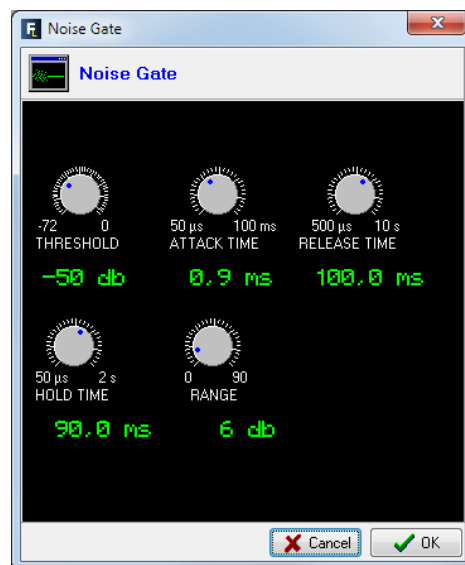

A noise gate is a dynamics processor that lets signals through whose level exceeds a certain threshold, strongly attenuating the signal levels below that threshold and thus muting noise. It enables its user to eliminate extraneous noise from a signal source, whether it is background noise in the studio, in the case of a microphone, or the background noise generated by a playback device, for example, a tape.

The available controls are:

- "THRESHOLD": determines the level above which signal is allowed through the gate.
- "ATTACK TIME": the time for the gate to react to a signal that is exceeding the threshold.
- "RELEASE TIME": the time that the gate should remain open once the signal exceeding threshold has disappeared.

- "HOLD TIME": the time that the gate should remain open when the signal falls below the threshold.
- "RANGE": the limit of dynamic range where created configuration will have effect.

The threshold must be adjusted to a level slightly higher than the level of the noise to be avoided. Thus, the threshold will be set at a very low level. Above the threshold, the noise gate does not act (unity gain), letting the rest of the signal through without processing it. The gate remains closed; i.e. when the signal surpasses the threshold level, the gate opens. The attack time is the time the gate takes to open (unity gain) when it receives a signal whose amplitude exceeds the threshold level; this time must be short to avoid cutting off the beginning of a sentence or song. The release time is the time the gate takes to close when the signal level falls below the threshold. The hold time is the minimum time during which the gate remains open; it is used to prevent the gate from closing when the signal level drops briefly—for example, when an announcer pauses while speaking. The hold time prevents the gate from opening and closing constantly in the presence of a signal whose level fluctuates in a range close to the threshold level.

4.3.4.3. Advanced configuration of Equalizer.

From the initial screen of the pre-sets advanced information menu ("Digital Sound Processes") you can configure and activate/deactivate the Equalizer operation.

When you select the "Active" checkbox, the "**Configure**" button gets active and gives you access to the graphic display where the Equalizer associated parameters can be modified.

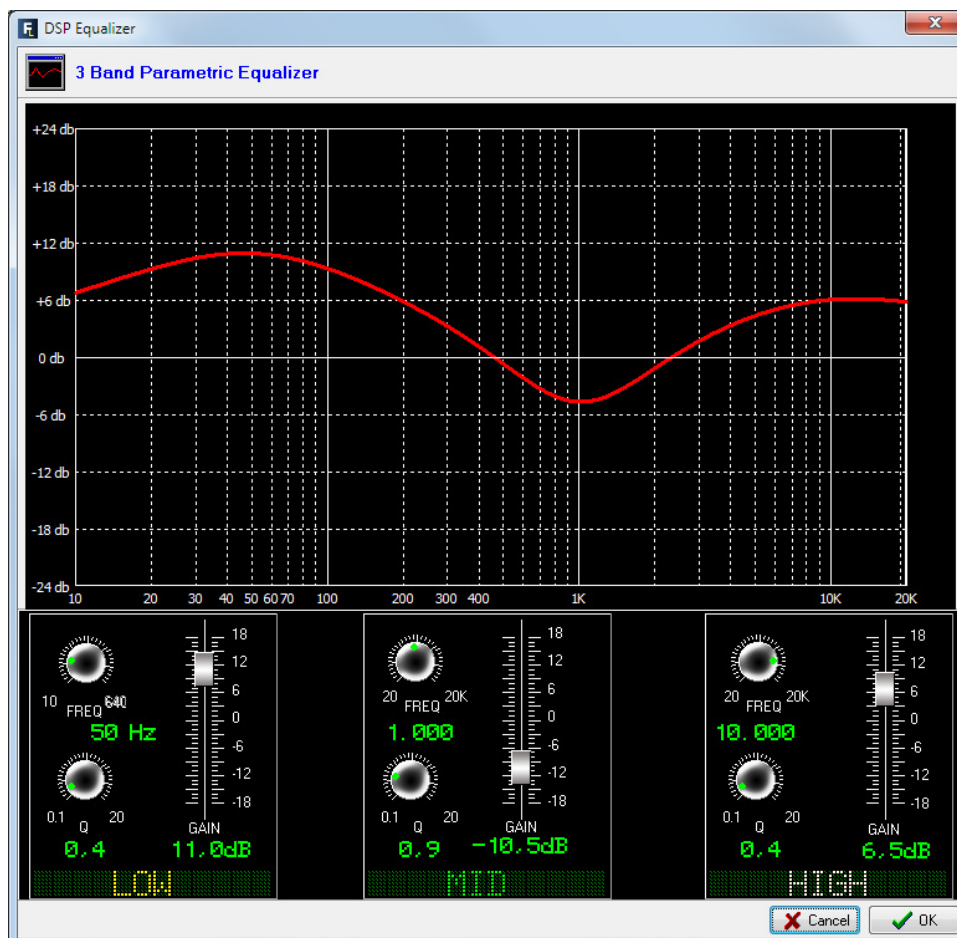

4.3.4.4. Advanced configuration of Low Pass Filter.

From the initial screen of the pre-sets advanced information menu ("Digital Sound Processes") you can configure and activate/deactivate the Low Pass Filter operation.

When you select the "Active" checkbox, the "Configure" button gets active and gives you access to the graphic display where the Low Pass Filter associated parameters can be modified.

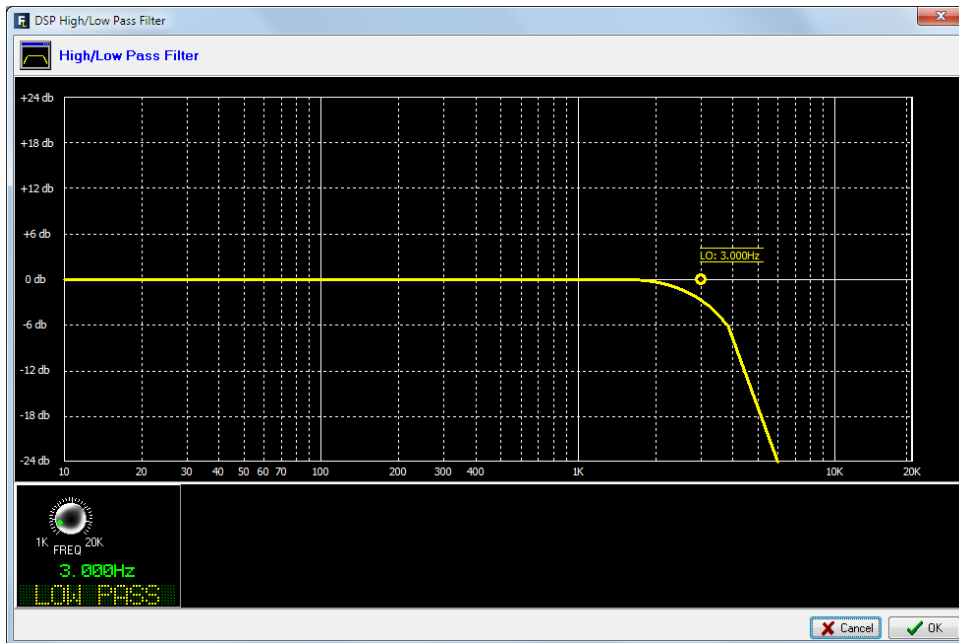

4.3.4.5. Advanced configuration of High Pass Filter.

From the initial screen of the pre-sets advanced information menu ("Digital Sound Processes") you can configure and activate/deactivate the High Pass Filter operation.

When you select the "Active" checkbox, the "Configure" button gets active and gives you access to the graphic display where the High Pass Filter associated parameters can be modified.

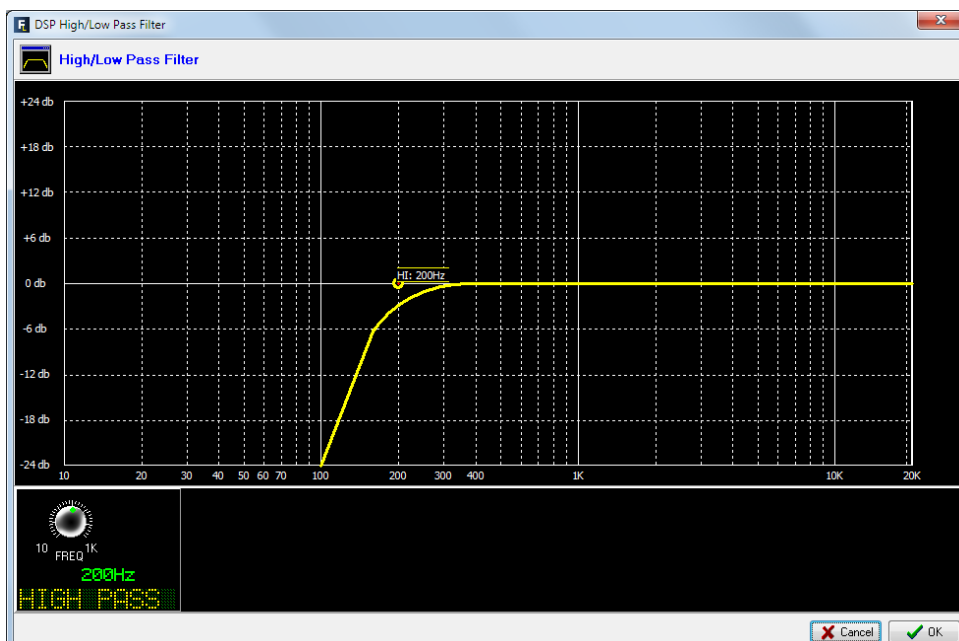

4.3.5. "SnapShot Configuration" submenu.

"SnapShot Configuration" submenu is accessed, from the drop-down menu "Programmable Configuration", by clicking on the icon:



"SnapShot Configuration" submenu allows you to manage the different configuration memories stored in AEQ FORUM LITE and available to operators through the internal menu of the main screen of the Control and Monitoring section of the unit (please refer to section 3.3 of this manual).

You can also load the configuration memories into the console by means of "Memory" type programmable keys (please refer to section 4.3.2.8 of this manual).

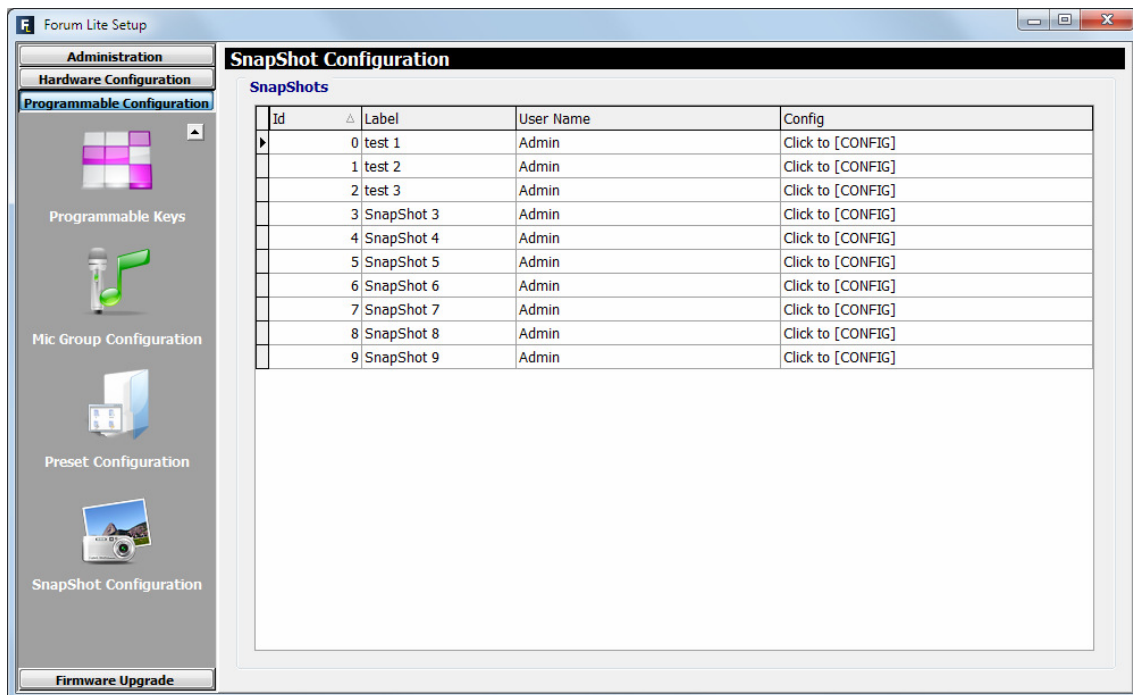

The main screen of this submenu is presented as a list of all the snapshots stored (there are up to 10 available snapshots), ordered by their "Id" and with a "Label" or name as identifier.

The "User Name" column allows you to assign each of the snapshots to a specific console user. The "<ALL>" option allows that any of the defined users can access to that snapshot. The first snapshot in the list, with "Id" 0, will also always be available to any user (even if the "LOGOU" key has been pressed and no user is loaded).

Id	Label	User Name
0	test 1	Admin
1	test 2	Admin
2	test 3	Admin
3	SnapShot 3	<ALL>
4	SnapShot 4	Admin
5	SnapShot 5	Super
6	SnapShot 6	Basic
7	SnapShot 7	Admin

The advanced configuration menu of each one of the snapshots is accessed by clicking "**Click to [CONFIG]**" and then clicking again on the  button that will appear. The screen you access to looks as follows:

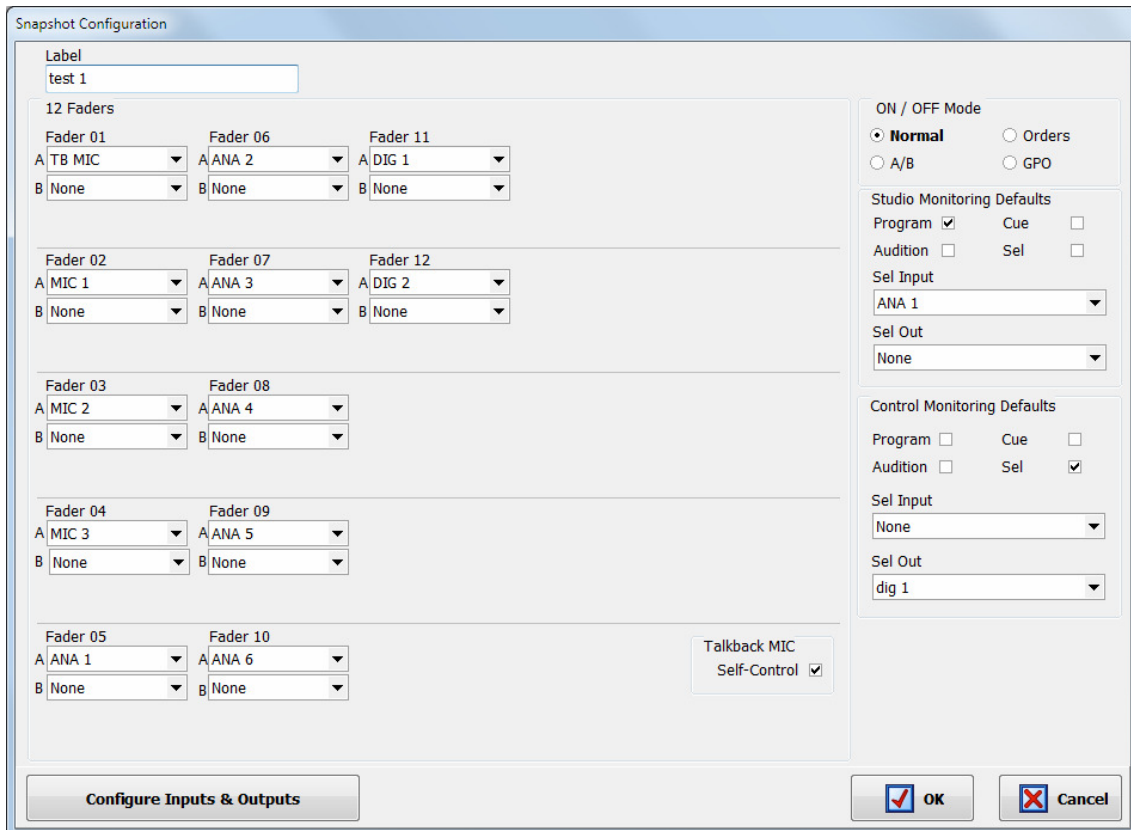

The available options in the snapshots advanced configuration menu, described from left to right and top to bottom, are:

- **"Label"**: alphanumeric label for the snapshot memory.
- **"Faders"**: a series of drop-down menus allow you to assign an input audio channel to each one of the physical faders of the control surface. The faders are numbered, from top to bottom and from left to right, 1 through the number previously defined in "Board Configuration" submenu (see section 4.2.1).
It's also possible to associate a **channel B** to each fader: if you press the channel activation lower key for more than 500 ms and then release it, a change of the assigned input will be accomplished, as long as mode "A/B" is activated in the snapshot (see next page) or if you press the "SELECT" key, when other mode is active and "A/B" mode is activated by means of a programmable key (see section 4.3.2.11 of this manual).
- **"Talkback MIC"**: allows you to configure the operation of the talkback microphone (microphone 4) at the rear panel of the AEQ FORUM LITE. When **"Self-Control"** checkbox is **not** activated, that input is configured only as an orders microphone toward studio or return for any open communication lines (this is a typical configuration for AEQ FORUM LITE when installed in a Studio/Control configuration). When **"Self-Control"** checkbox is activated, that input 4 is configured as autocontrol microphone (it simultaneously works as orders microphone), so the host of the radio program is also the operator of the mixing console (this is a typical configuration when the Studio and Control areas of the radio station are in the same room). Only when "Self-Control" checkbox is activated you can assign the talkback mic to a fader (when it's not activated, the mic will not appear in the channels list).
- **"ON / OFF Mode"**: section where you can configure the working mode of the **channel activation keys**. There are 4 options:

ON / OFF Mode

Normal Orders
 A/B GPO

- **"Normal"**: the upper red key is associated with **ON** function and the lower yellow key is associated with **OFF** function. The operation is exclusive, both keys can not be turned on simultaneously.
- **"Orders"**: when you press and keep pressed the **lower** key you send the orders microphone to the output channel associated with the input present at the channel (Talkback functionality). The **upper** key is associated with **ON/OFF** function (allows you to activate/deactivate the channel).

When this option is selected a new field ("**Orders**") associated with each one of the faders is shown and allows to assign that output channel (it can also be defined in the advanced configuration menu of the input channel: see section 4.2.3.1 of this manual).

Snapshot Configuration

Label
test 1

12 Faders

<p>Fader 01</p> <p>A TB MIC</p> <p>B None</p> <p>None</p> <p>Orders</p>	<p>Fader 06</p> <p>A MIC 5</p> <p>B None</p> <p>ana 3</p> <p>Orders</p>	<p>Fader 11</p> <p>A ANA 4</p> <p>B None</p> <p>None</p> <p>Orders</p>
<p>Fader 02</p> <p>A MIC 1</p> <p>B None</p> <p>dig 1</p> <p>Orders</p>	<p>Fader 07</p> <p>A MIC 6</p> <p>B None</p> <p>ana 4</p> <p>Orders</p>	<p>Fader 12</p> <p>A ANA 5</p> <p>B None</p> <p>None</p> <p>Orders</p>
<p>Fader 03</p> <p>A MIC 2</p> <p>B None</p> <p>dig 2</p> <p>Orders</p>	<p>Fader 08</p> <p>A ANA 1</p> <p>B None</p> <p>None</p> <p>Orders</p>	
<p>Fader 04</p> <p>A MIC 3</p> <p>B None</p> <p>None</p> <p>Orders</p>	<p>Fader 09</p> <p>A ANA 2</p> <p>B None</p> <p>None</p> <p>Orders</p>	
<p>Fader 05</p> <p>A MIC 4</p> <p>B None</p> <p>None</p> <p>Orders</p>	<p>Fader 10</p> <p>A ANA 3</p> <p>B None</p> <p>None</p> <p>Orders</p>	

- **"A/B"**: if you press the **lower** key for more than 500 ms, when you release it a fast change of the input assigned to the channel is accomplished (the new input will be shown in the channel display). The **upper** key is associated with **ON/OFF** function (allows you to activate/deactivate the channel).

When this option is selected the input selected in drop-down menu "**B**" is the one you'll change to by that long press.

You can also activate this working mode by means of a programmable key: in that case the signal change will be accomplished by pressing the "SELECT" key while programmable key remains pressed (see section 4.3.2.11 of this manual).

Snapshot Configuration

Label
test 1

12 Faders

Fader 01		Fader 06		Fader 11	
A	TB MIC	A	MIC 5	A	ANA 4
B	None	B	None	B	None
Fader 02		Fader 07		Fader 12	
A	MIC 1	A	MIC 6	A	ANA 5
B	DIG 1	B	None	B	None
Fader 03		Fader 08			
A	MIC 2	A	ANA 1		
B	DIG 2	B	None		
Fader 04		Fader 09			
A	MIC 3	A	ANA 2		
B	DIG 3	B	None		
Fader 05		Fader 10			
A	MIC 4	A	ANA 3		
B	DIG 4	B	None		

- **"GPO"**: when you press and keep pressed the **lower** key you activate the physical or virtual GPO output associated with the input present at the channel (the GPO is deactivated when you release the key). The **upper** key is associated with **ON/OFF** function (allows you to activate/deactivate the channel).

When this option is selected a new field ("**GPO**") associated with each one of the faders is shown and allows to assign that GPO (it can also be defined in the advanced configuration menu of the input channel: see section 4.2.3.1 of this manual). You can not associate the same GPO to several channels.

Snapshot Configuration

Label
test 1

12 Faders

Fader 01			Fader 06			Fader 11		
A	TB MIC	▼	A	MIC 5	▼	A	ANA 4	▼
B	None	▼	B	None	▼	B	None	▼
	None	▼		None	▼		None	▼
	GPO			GPO			GPO	
Fader 02			Fader 07			Fader 12		
A	MIC 1	▼	A	MIC 6	▼	A	ANA 5	▼
B	DIG 1	▼	B	None	▼	B	None	▼
	GPO03	▼		None	▼		None	▼
	GPO			GPO			GPO	
Fader 03			Fader 08					
A	MIC 2	▼	A	ANA 1	▼			
B	DIG 2	▼	B	None	▼			
	GPO04	▼		GPO07	▼			
	GPO			GPO				
Fader 04			Fader 09					
A	MIC 3	▼	A	ANA 2	▼			
B	DIG 3	▼	B	None	▼			
	None	▼		None	▼			
	GPO			GPO				
Fader 05			Fader 10					
A	MIC 4	▼	A	ANA 3	▼			
B	DIG 4	▼	B	None	▼			
	None	▼		None	▼			
	GPO			GPO				

- **"Studio Monitoring Defaults"**: section where you can configure the initial activation of one or several keys to send signal to monitor and headphones placed under the display of the **studio** monitoring section. The available options are "Program", "Audition", "Cue" and "Sel" (when section is configured in **"Exclusive"** mode, you can activate only one key: see section 4.2.4.1 of this manual). **"Sel Input"** and **"Sel Out"** drop-down menus allows you to select a single input, output or internal summing bus to associate it initially with the "SEL" monitoring key (that selection can be modify later by means of "HP/SOURCE" encoder).

Studio Monitoring Defaults

Program Cue

Audition Sel

Sel Input
DIG 1 ▼

Sel Out
None ▼

- **"Control Monitoring Defaults"**: section where you can configure the initial activation of one or several keys to send signal to monitor and headphones placed under the display of the **control** monitoring section. The available options are "Program", "Audition", "Cue" and "Sel" (when section is configured in **"Exclusive"** mode, you can activate only one key: see section 4.2.4.2 of this manual). **"Sel Input"** and **"Sel Out"** drop-down menus allows you to select a single input, output or internal summing bus to associate it initially with the "SEL" monitoring key (that selection can be modify later by means of "HP/SOURCE" encoder).

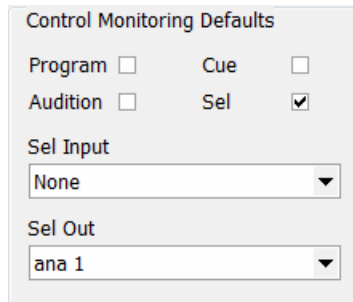

- **"Configure Inputs & Outputs"**: this button gives you a quick access to the advanced configuration section for audio inputs and outputs channels, presented in two consecutive columns.

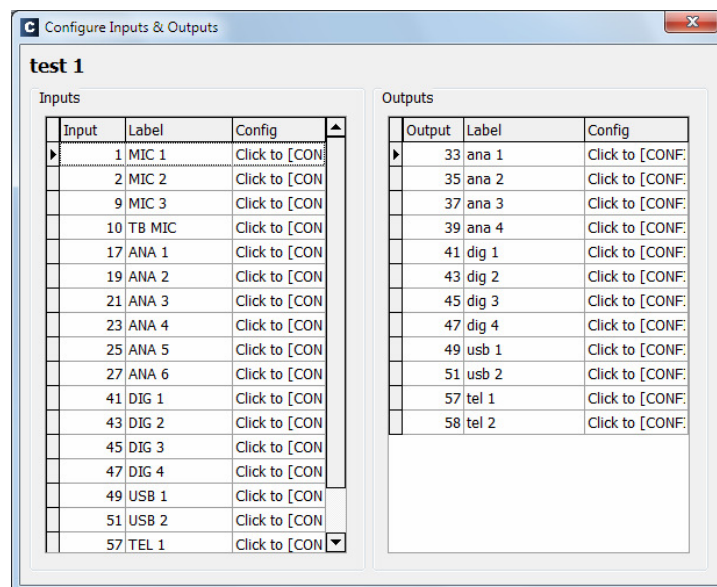
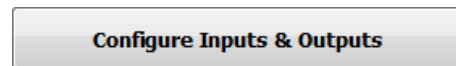

- **"OK"**: allows you to accept the created or edited configuration.
- **"Cancel"**: allows you to reject the created or edited configuration. No change you may have made is saved.

4.3.5.1. Advanced configuration of inputs.

Within the "Configure Inputs & Outputs" advanced configuration screen, the left part of the screen shows the complete list of all the available audio input channels. Three columns are shown:

- **"Input"**: shows the internal numeric identifier for the input.
- **"Label"**: shows the name or label associated with the channel.
- **"Config"**: allows you to configure the associated options for that input channel from a specific screen. You can access by clicking **"Click to [CONFIG]"** and then clicking again on the  button that will appear.

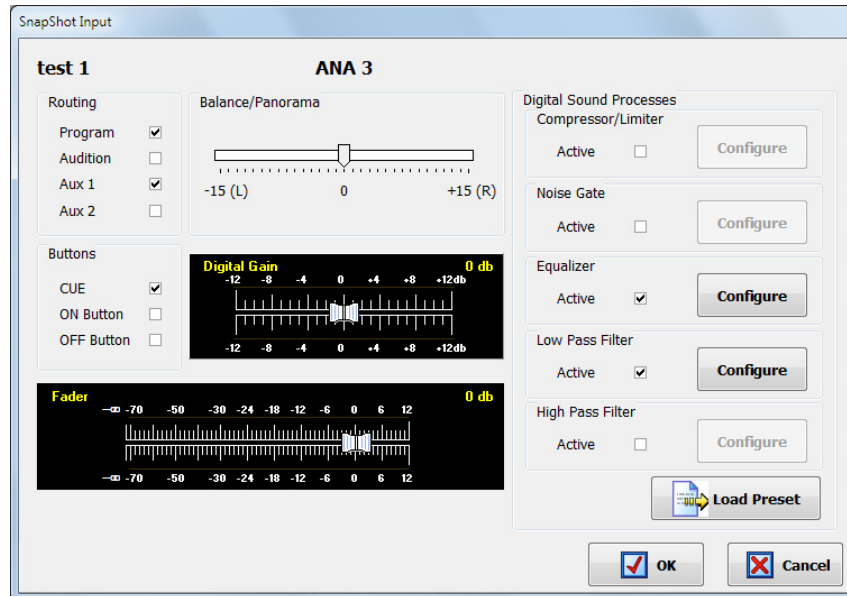

From left to right and from top to bottom the available options are:

- Name of the snapshot (test 1 in the example).
- Name of the channel (ANA 3 in the example).
- **"Routing"**: allows you to configure the initial activation (or not) of the quick routing keys that are available above each fader channel of AEQ FORUM LITE control surface.
- **"Balance/Panorama"**: allows you to manage the initial balance or panoramic control for this input channel.
- **"Buttons"**: allows you to configure the initial status of the PFL sending button ("**CUE**") and the CHANNEL ON/OFF keys of AEQ FORUM LITE control surface.
- **"Digital Gain"**: allows you to control the initial input gain of the selected channel from -12dB to +12 dB, by means of a graphical representation of a sliding fader (from -36 to +19dB in the case of microphone/line inputs).
- **"Fader"**: allows you to configure the initial virtual position of that channel fader. **IMPORTANT NOTE:** This configuration will take effect when that channel is not associated with a physical fader in the control surface; when it's associated with a fader, the value corresponding to that physical fader position will be taken.
- **"Digital Sound Processes"**: allows you to configure and activate/deactivate initially the available processes for that channel or, by means of "**Load Preset**" button, to select and load a previously created preset (see section 4.3.4).
- **"OK"**: allows you to accept the created or edited configuration.
- **"Cancel"**: allows you to reject the created or edited configuration. No change you may have made is saved.

In case you select any of the 4 microphone/line inputs, an additional option appears at the bottom of the screen:

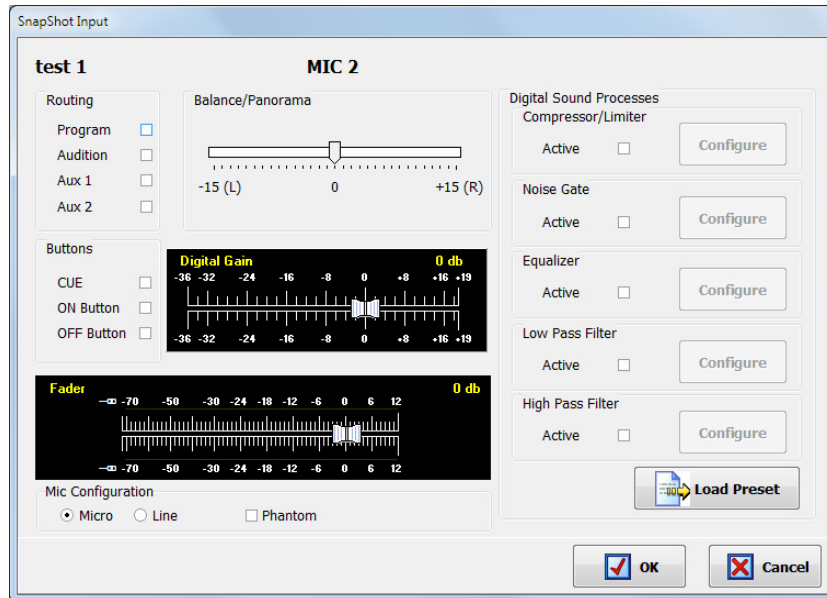

- **"Mic Configuration"**: this option, which is only available for the audio core edition called **MCORE**, allows you to configure the selected input as a microphone or line input and, if configured as microphone, it allows you to activate or not the Phantom power. In case that it's not an MCORE, this configuration must be carried out using programming jumpers, as indicated in section 2.2.3.6 of this manual.

4.3.5.2. Advanced configuration of outputs.

Within the "Configure Inputs & Outputs" advanced configuration screen, the right part of the screen shows the complete list of all the available audio output channels. Three columns are shown:

- **"Output"**: shows the internal numeric identifier for the output.
- **"Label"**: shows the name or label associated with the channel.
- **"Config"**: allows you to configure the associated options for that output channel from a specific screen. You can access by clicking **"Click to [CONFIG]"** and then clicking again on the  button that will appear.

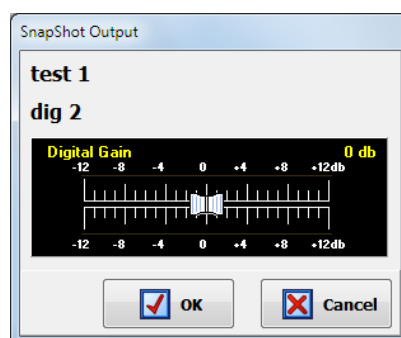

From left to right and from top to bottom the available options are:

- Name of the snapshot (test 1 in the example).
- Name of the channel (dig 2 in the example).
- **"Digital Gain"**: allows you to control the output gain of the selected channel from -12dB to +12 dB, by means of a graphical representation of a sliding fader.
- **"OK"**: allows you to accept the created or edited configuration.
- **"Cancel"**: allows you to reject the created or edited configuration. No change you may have made is saved.

4.4. "Firmware Upgrade" menu.

This menu allows you to update the firmware versions for the AEQ FORUM LITE, allowing for the implementation of new features and developments in future versions. Clicking on the "Firmware Upgrade" section on the main screen, the left side of the screen will show you the list of submenus, which includes:

- **"Tree View"**: provides a global view of the system, providing information regarding the currently installed firmware versions for each of the integrated and optional modules that AEQ FORUM LITE mixing console contains.
- **"Upgrade View"**: shows information regarding the system functional module to be updated and the overall progress of the Firmware Upgrade operation.
- **"Log View"**: log containing all the actions associated with an upgrade process.

IMPORTANT NOTE: Any operation in this "Firmware Upgrade" section should only be accomplished by qualified personnel in possession of all necessary technical information relative to this system and with the possibility to establish a direct communication with **AEQ's Technical Service** (support@aeq.es). Depending on the previous versions of the console, after upgrading process the console may lose its configuration, so **it's always recommended to save the console configuration** in a **LSC** file by means of "Export" option in "Forum Lite Setup" application (see section 4.1.1 of this manual).

In order to execute this menu available options, it is necessary that the "Forum Lite Setup" application is in direct communication with the AEQ FORUM LITE mixer, through its Ethernet port ("LAN") at the audio engine back panel. In case there is no connection to console, the associated submenus will be shown blank.

4.4.1. "Tree View" submenu.

"Tree View" submenu is accessed, from the drop-down menu "Firmware Upgrade", by clicking on the icon:

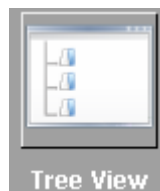

"Tree View" submenu provides a global view of the system, with a tree structured diagram, providing information regarding the currently installed firmware versions for each of the integrated and optional modules that AEQ FORUM LITE mixing console contains.

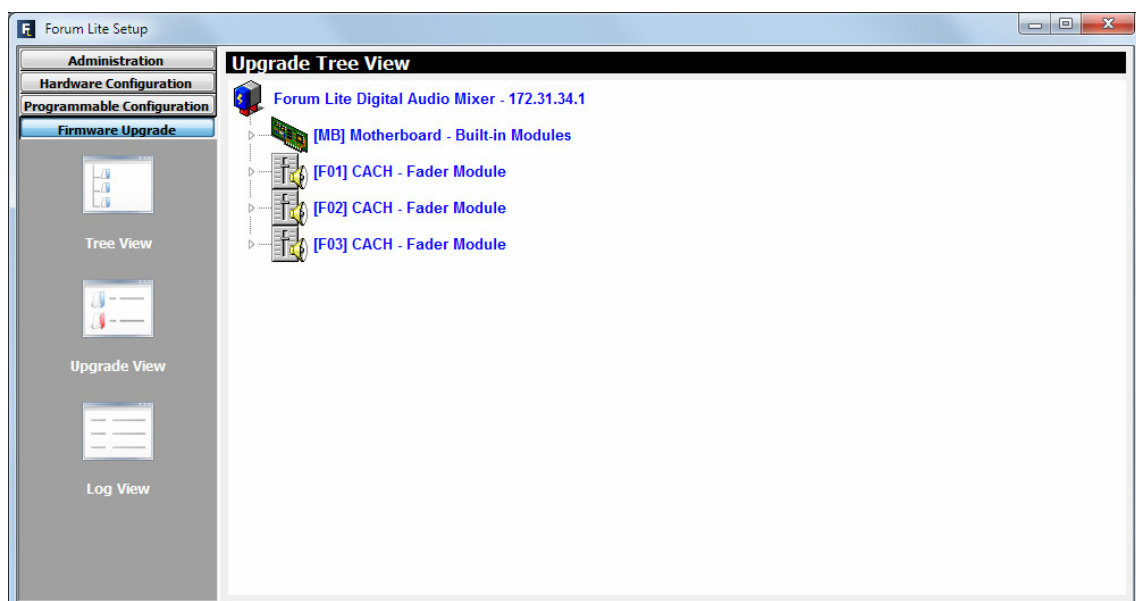

Selecting any of the modules, the associated firmware information will be shown.

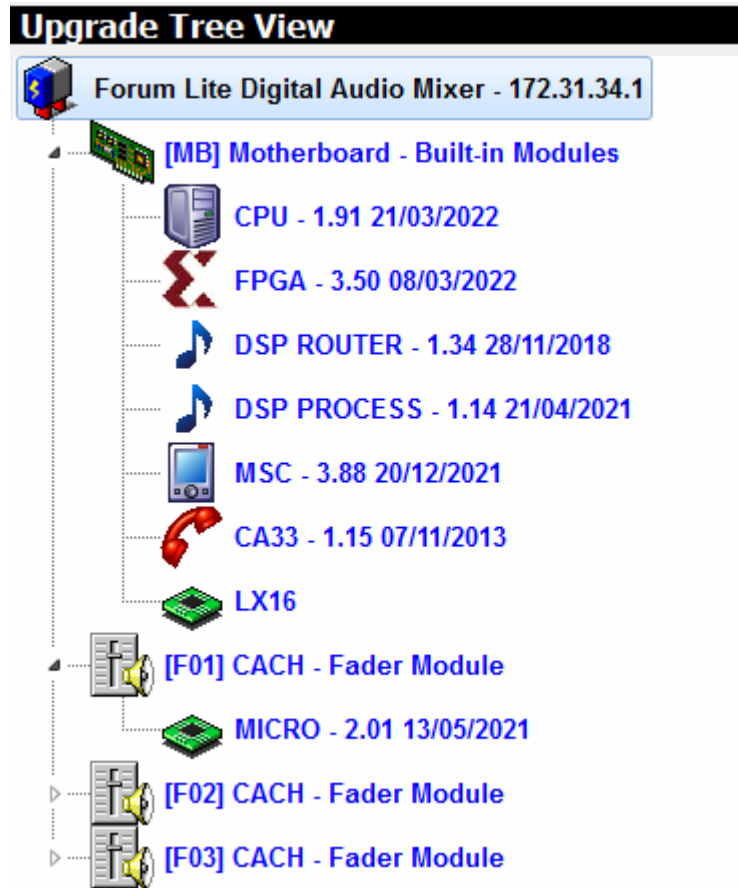

IMPORTANT NOTE: The symbol  LX16 indicates that the FPGA module chip is the LX16 model

If no symbol appears, it indicates that the chip is the LX9 model.

Each model has associated **exclusive** firmware versions for **CPU** and **FPGA** modules. If you have any doubt, consult AEQ Technical Service.

The procedure to upgrade a module firmware is as follows:

1. Place the pointer on the module to be upgraded, press the right mouse button and then the "Upgrade" option that appears.

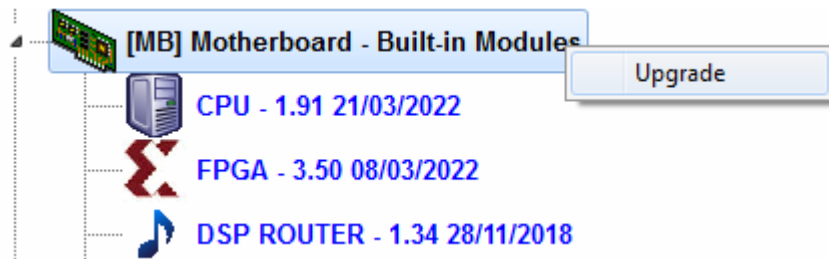

2. In the new window that appears, press the  button and select the "AFU" upgrading file (AEQ Firmware Upgrade) that contains the new version you want to load.

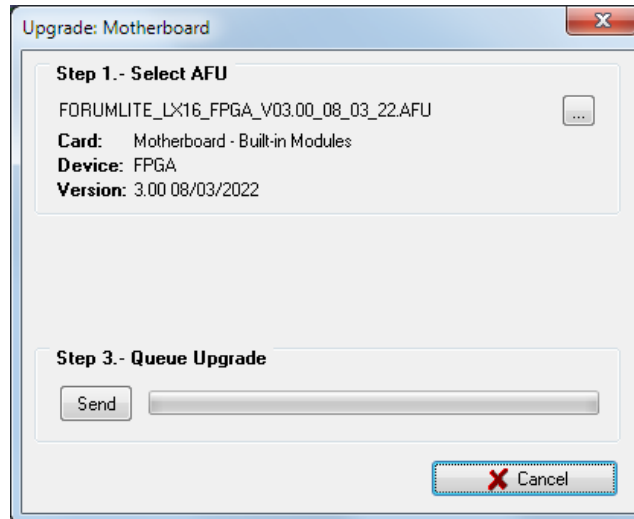

In case you select an AFU file that does not correspond to the selected module, an error message will be displayed:

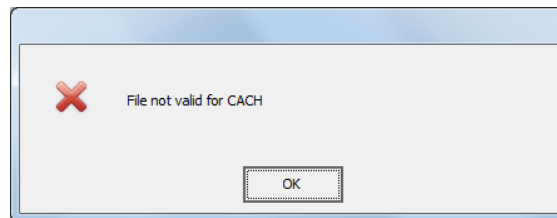

3. Then press "**Send**" button to start the upgrading process.
4. From this point on, the application changes automatically to "**Upgrade View**" screen in order to show you the upgrading progress. See section 4.4.2 of this manual.

IMPORTANT NOTE: You should not act on the system and you must never turn off the equipment during the upgrading process, since this action may deprogram the module that you are trying to upgrade. The **firmware upgrade right order** is: **CACH fader module/s**, **MSC module** and **BASE PBA** (DSP Process, DSP Router, CPU and FPGA). The **CA33** telephone hybrid module will appear as an upgradeable module inside the base board (as well as an independent module when installed) and will be upgraded from here. The **AoIP** module (in case it's installed) will be upgraded by means of "**DANTE Firmware Update Manager**" application.

As previously indicated, there are 2 models of the **FPGA** module chip: **LX9** and **LX16**. Each model has associated **exclusive** firmware versions for **CPU** and **FPGA** modules. In case you select an AFU file that does not correspond to the installed FPGA model, an error message will be displayed:

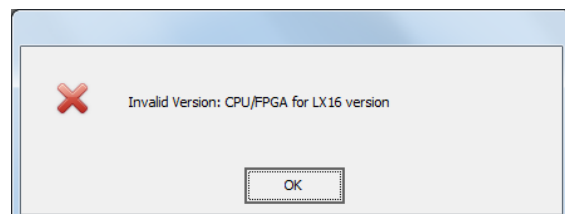
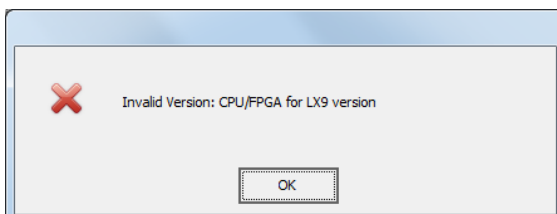

In the case of the **CACH** and **MSC** module there are several board editions and some of them have associated exclusive firmware versions. In case you select an AFU file that does not correspond to the board edition, an error message will be displayed:



4.4.2. "Upgrade View" submenu.

"Upgrade View" submenu is accessed, from the drop-down menu "Firmware Upgrade", by clicking on the icon (although the application will change automatically to this submenu when an firmware upgrading is in process):

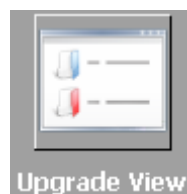

"Upgrade View" submenu allows you to check in real time the upgrading progress.

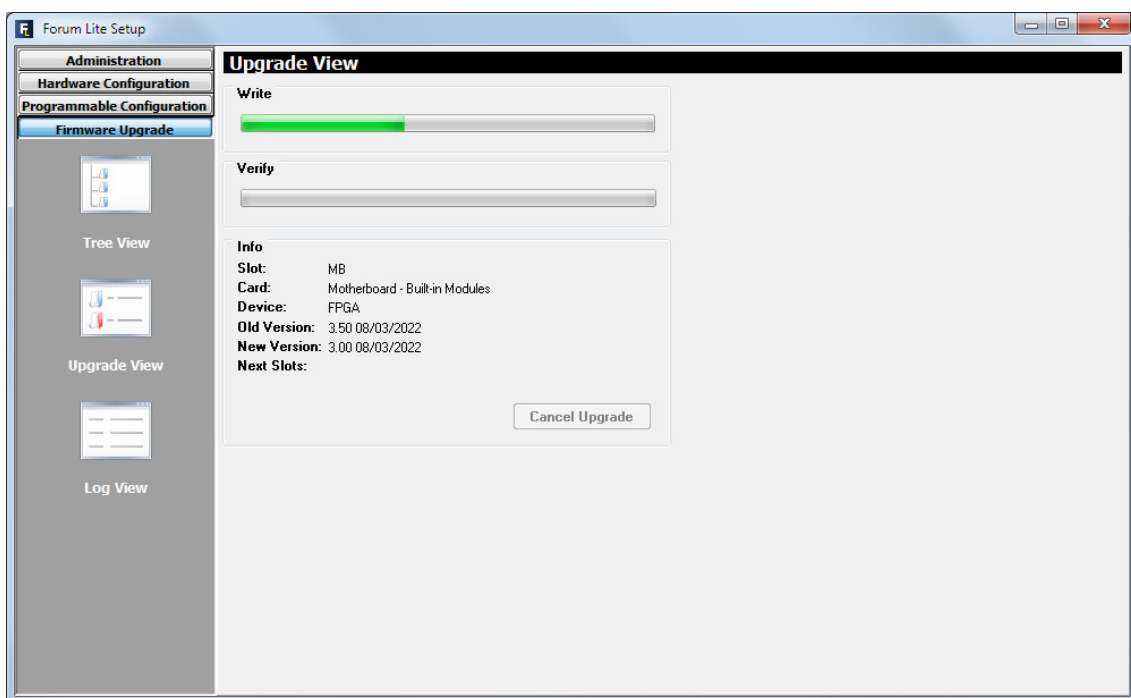

The following fields are visible on screen:

- **"Write"**: progress bar concerning the AFU file copy process from the computer that is running "Forum Lite Setup" application to the AEQ FORUM LITE internal memory.
- **"Verify"**: progress bar for the AFU file check previously copied to the AEQ FORUM LITE internal memory.
- **"Info"**: displays information about the functional module of the AEQ FORUM LITE subject to the firmware upgrade:
 - **"Slot"**: identifies the logical location of the module to be upgraded. In case of a base board module, MB (Mother Board) indication will be shown. In case of a CACH 4 faders module, its position will be shown (F01, F02...).
 - **"Card"**: shows the type of the functional module that is subject to the firmware upgrade.

- **"Device"**: electronic component part of the functional module that will be upgraded.
- **"Old Version"**: information regarding the old firmware version installed on the component.
- **"New Version"**: information about new firmware version installed on the component.
- **"Next Slots"**: indicates the position of the following functional modules to be upgraded.

4.4.3. "Log View" submenu.

"Log View" submenu is accessed, from the drop-down menu "Firmware Upgrade", by clicking on the icon:

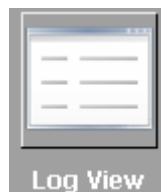

"Log View" submenu represents the record containing all the actions associated with a particular upgrade process as a sequence of independent events chronologically ordered and its specific status (OK or ERROR). This information is complementary information to "Tree View" and "Upgrade View" submenus.

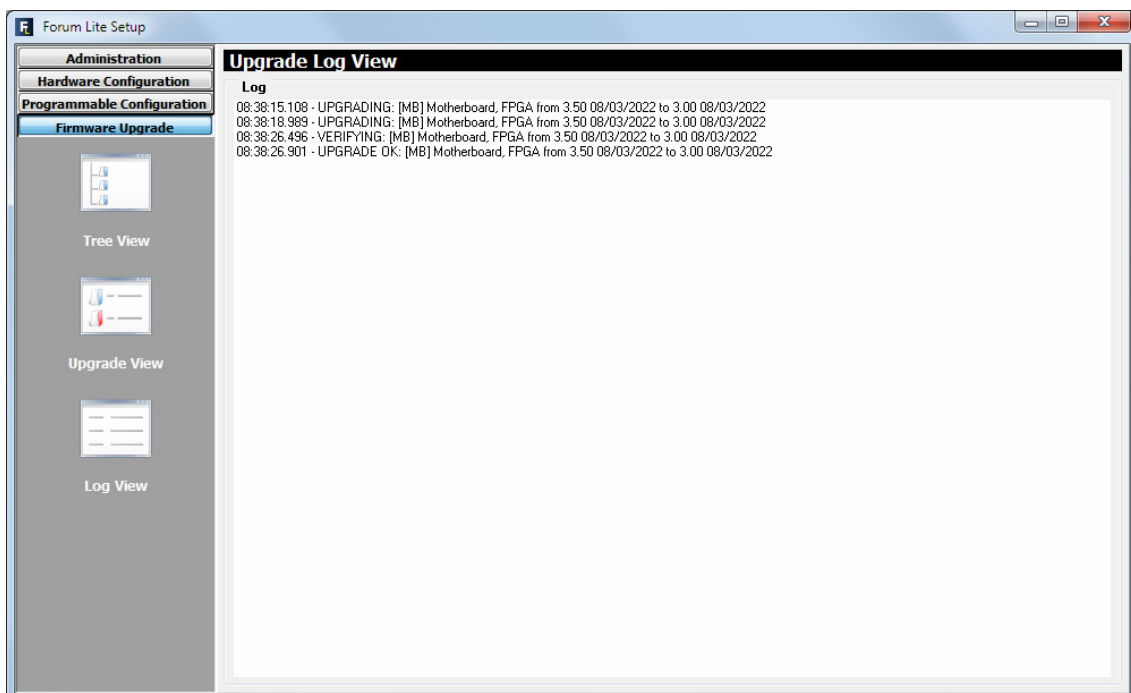

5. A.E.Q. GUARANTEE.

AEQ warrants that this product has been designed and manufactured under a certified Quality Assurance System. AEQ therefore warrants that the necessary test protocols to assure the proper operation and the specified technical characteristics of the product have been followed and accomplished.

This includes that the general protocols for design and production and the particular ones for this product are conveniently documented.

1.- The present guarantee does not exclude or limit in any way any legally recognized right of the client.

2.- The period of guarantee is defined to be twelve natural months starting from the date of purchase of the product by the first client.

To be able to apply to the established in this guarantee, it is compulsory condition to inform the authorized distributor or –to its effect- an AEQ Sales office or the Technical Service of AEQ within thirty days of the appearance of the defect and within the period of guarantee, as well as to facilitate a copy of the purchase invoice and serial number of the product.

It will be equally necessary the previous and expressed conformity from the AEQ Technical Service for the shipment to AEQ of products for their repair or substitution in application of the present guarantee.

In consequence, return of equipment that does not comply with these conditions will not be accepted.

3.- AEQ will at its own cost repair the faulty product once returned, including the necessary labour to carry out such repair, whenever the failure is caused by defects of the materials, design or workmanship. The repair will be carried out in any of the AEQ authorized Technical Service Centre. This guarantee does not include the freight charges of the product to or from such Authorized Technical Service Centre.

4.- No Extension of the Guarantee Period for repaired product shall be applied. Nor shall a Substituted Products in application of this Guarantee be subject to Guarantee Period Extension.

5.- The present guarantee will not be applicable in the following situations:
Improper use or Contrary use of the product as per the User or Instruction Manual; violent manipulation; exhibition to humidity or extreme thermal or environmental conditions or sudden changes of such conditions; electrical discharges or lightning; oxidation; modifications or not authorized connections; repairs or non-authorized disassembly of the product; spill of liquids or chemical products.

6.- Under no circumstances, whether based upon this Limited Guarantee or otherwise, shall AEQ, S.A. be liable for incidental, special, or consequential damages derived from the use or from the impossibility of using the product.

AEQ shall not be liable for loss of information in the disks or data support that have been altered or found to be inexact, neither for any accidental damage caused by the user or other persons manipulating the product.

APPENDIX A. SIGNALLING CONNECTION.

Next, an example of connection of red light signalling in studio and control rooms is described.

The pinout of "RELAYS" DB15 connector is detailed in section 2.2.2.1.3 of this manual and the pinout of CP CAB GPIO cable in section 2.2.5.

First of all, in the "Forum Lite Setup" application, it's necessary to configure in the "Monitoring Configuration" submenu of "Hardware Configuration" menu which relays will be used for ON AIR signalling of studio and control rooms. See section 4.2.4 of this manual.

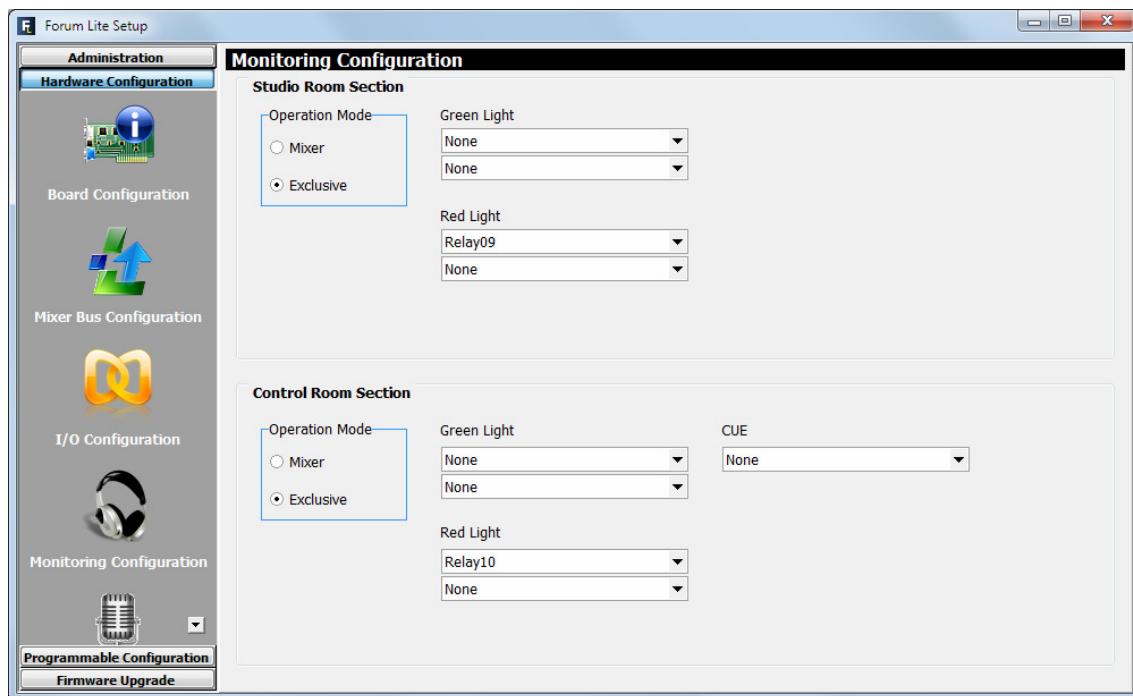

In the example, the first of the available relays ("Relay09") is assigned to the studio room red light and the second relay ("Relay10") to the control room red light. Once this section is configured, logically the configuration must be sent to the console.

Next, the connection to be made is detailed. Logically, if instead of using these 2 relays others are chosen, the connections indicated in the connection terminal should be adapted.

It's **IMPORTANT** not to connect the CP CAB GPIO cable to the console before making the connections to the signalling system.

The connections in the terminal must be made with the power supply of the lights disconnected.

The handling and connection of the mixer, as well as the signalling wiring, must be carried out by qualified personnel. AEQ is not responsible for any damage caused to the mixer during installation, configuration or improper handling of the AEQ FORUM LITE mixer.

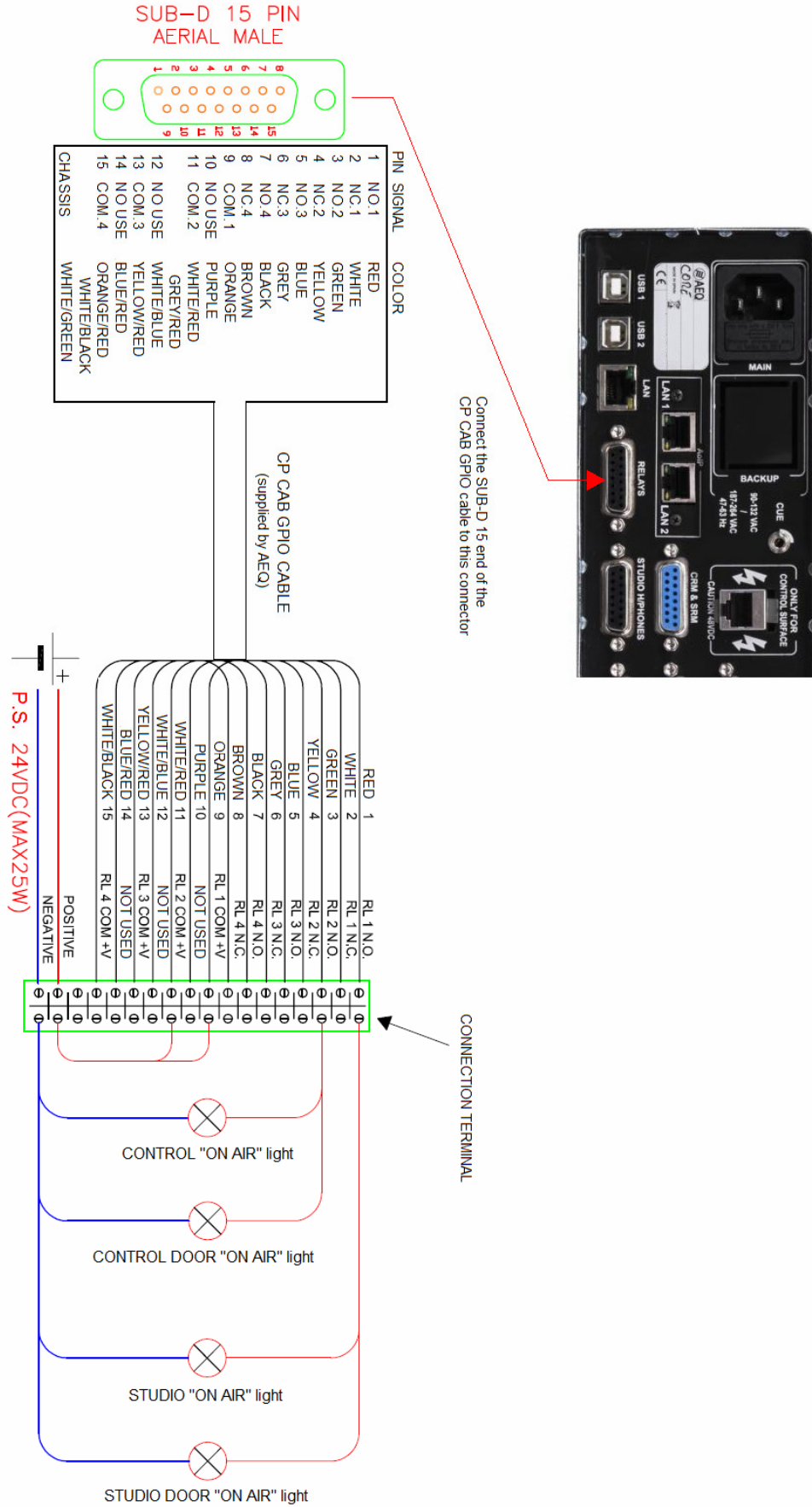

There is another option (LAZSA) regarding the color code. It would be as follows:

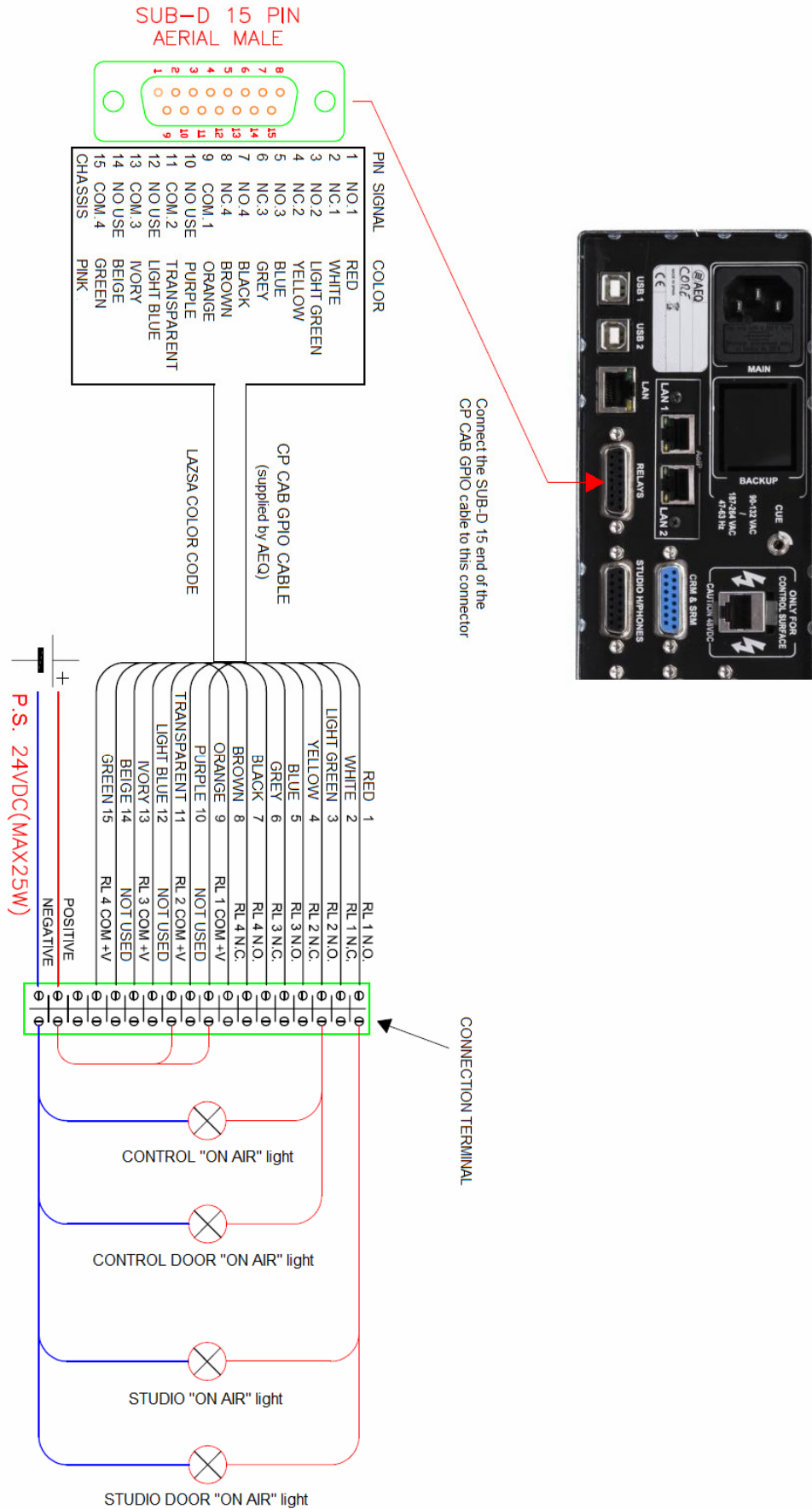

In case you also want to take the signalling to a **STUDIOBOX**, the previous scheme could be as follows:

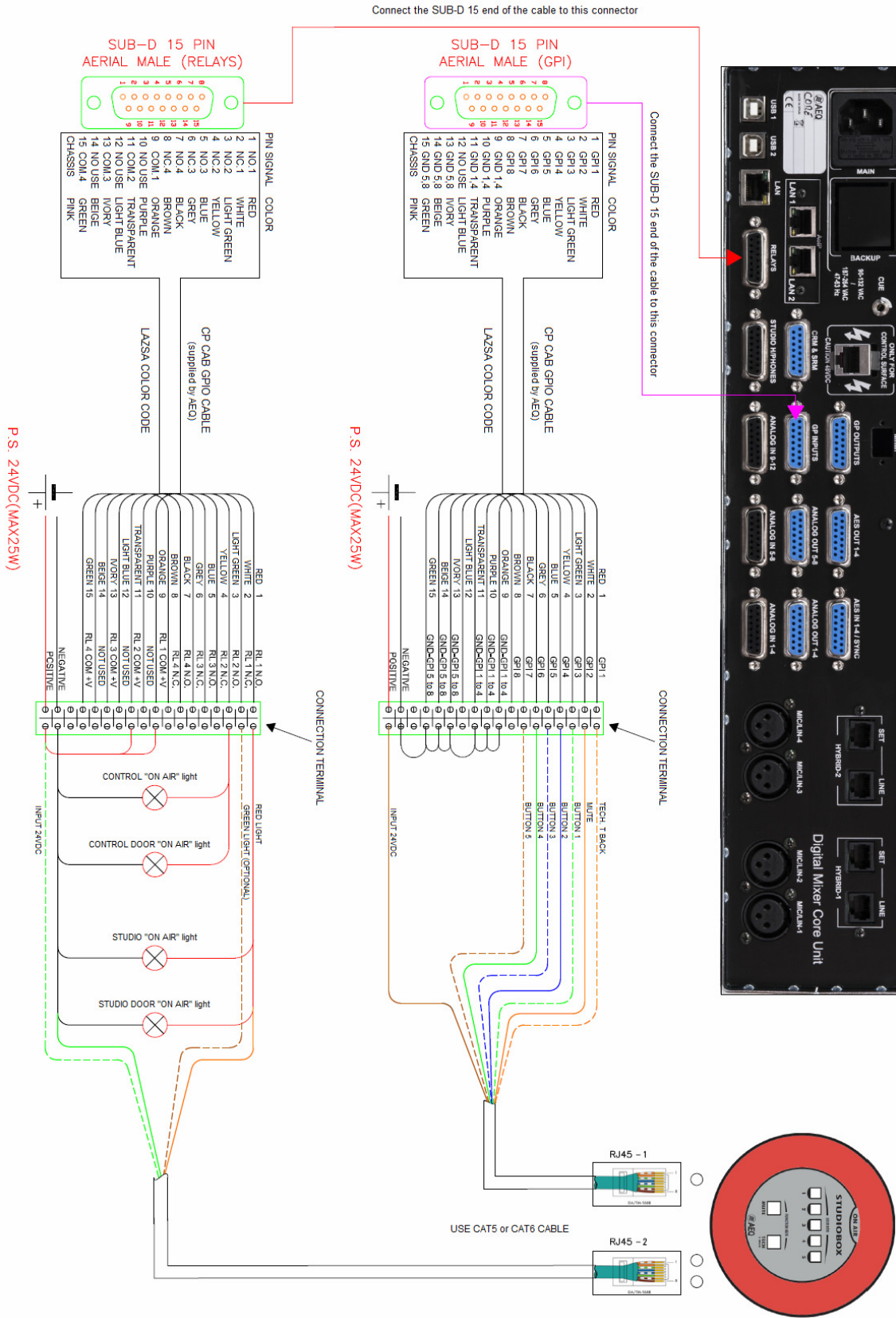

The color code of the RJ45 connectors that go to the STUDIOBOX is as follows:

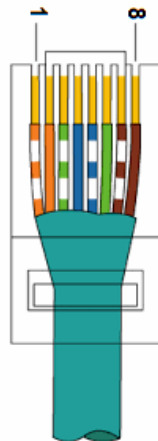

PIN	COLOR
1	White/Orange
2	Orange
3	White/Green
4	Blue
5	White/Blue
6	Green
7	White/Brown
8	Brown

The diagram also shows the connection associated with the buttons of the STUDIOBOX signaling box (RJ45-1). The corresponding cable will be connected to "GP INPUTS" DB15 connector of the console.

This connection will also be associated with previous programming in the "Forum Lite Setup" application. In the example, the "TECH T. BACK" button of the STUDIOBOX is connected to GPI 1 of the console and that GPI would be associated with the "Remote PFL" function of one of the console inputs. Similarly, the "MUTE" button is connected to GPI 2 of the console and that GPI would be associated with the "Cough Cut" or "Mute" function of one or more console inputs. On the other hand, USERS KEY 1 to 5 are respectively connected to GPIs 3 to 7 of the console and any of the functions available in the console could be associated to each of them (a "Remote ON/OFF" of an input or the activation of a salvo for example). See sections 4.2.3.1 and 4.3.2 of this manual.

APPENDIX B. ADDITIONAL INFORMATION.

NOTE: This equipment complies with the limits for a Class A digital device, pursuant to part 15 of the **FCC** Rules. These limits are designed to provide reasonable protection against harmful interference when the equipment is operated in a commercial environment. This equipment generates, uses, and can radiate radio frequency energy and, if not installed and used in accordance with the instruction manual, may cause harmful interference to radio communications. Operation of this equipment in a residential area is likely to cause harmful interference in which case the user will be required to correct the interference at his own expense.



Dante™ is a trademark of **Audinate Pty Ltd.**

Product includes license from Audinate Pty Ltd under US patent number(s) 7747725, 8005939, 7978696, 8171152 and others. Visit Audinate website for more details on Dante:
<http://www.audinate.com/>